PAIN RELIEF PROMOTION ACT

HEARING
BEFORE THE
COMMITTEE ON THE JUDICIARY
UNITED STATES SENATE
ONE HUNDRED SIXTH CONGRESS
SECOND SESSION
ON
H.R. 2260
APRIL 25, 2000
Serial No. J-106-77

Printed for the use of the Committee on the Judiciary



U.S. GOVERNMENT PRINTING OFFICE

72-844

WASHINGTON : 2001

For sale by the Superintendent of Documents, U.S. Government Printing Office
Internet: bookstore.gpo.gov Phone: (202) 512-1800 Fax: (202) 512-2250
Mail: Stop SSOP, Washington, DC 20402-0001

COMMITTEE ON THE JUDICIARY

ORRIN G. HATCH, Utah, *Chairman*

STROM THURMOND, South Carolina

CHARLES E. GRASSLEY, Iowa

ARLEN SPECTER, Pennsylvania

JON KYL, Arizona

MIKE DEWINE, Ohio

JOHN ASHCROFT, Missouri

SPENCER ABRAHAM, Michigan

JEFF SESSIONS, Alabama

BOB SMITH, New Hampshire

PATRICK J. LEAHY, Vermont

EDWARD M. KENNEDY, Massachusetts

JOSEPH R. BIDEN, JR., Delaware

HERBERT KOHL, Wisconsin

DIANNE FEINSTEIN, California

RUSSELL D. FEINGOLD, Wisconsin

ROBERT G. TORRICELLI, New Jersey

CHARLES E. SCHUMER, New York

MANUS COONEY, *Chief Counsel and Staff Director*

BRUCE A. COHEN, *Minority Chief Counsel*

CONTENTS

STATEMENT OF COMMITTEE MEMBER

	Page
Hatch, Hon. Orrin G., a U.S. Senator from the State of Utah	1

WITNESSES

Bleich, Rabbi J. David, on behalf of the Union of Orthodox Jewish Congregations of America	59
Caplan, Arthur L., Director, Center for Bioethics, and Trustee Professor, University of Pennsylvania	57
Chevlen, Eric, M.D., Director of Palliative Care, Cancer Care Center, St. Elizabeth Hospital	42
Foley, Kathleen, M.D., Attending Neurologist, Memorial Sloan-Kettering Cancer Center	63
Hunter, Walter R. M.D., Associate National Medical Director, Vista Care Hospice	69
Nickles, Hon. Don, a U.S. Senator from the State of Oklahoma	4
Smith, Hon. Gordon, a U.S. Senator from the State of Oregon	37
Wyden, Hon. Ron, a U.S. Senator from the State of Oregon	21

APPENDIX

PROPOSED LEGISLATION

Bill H.R. 2260	83
----------------------	----

ADDITIONAL SUBMISSIONS FOR THE RECORD

American Nurses Association, prepared statement	97
Campbell, James N. M.D., Johns Hopkins Medicine, Department of Neurosurgery, letter	95
Fins, Joseph J., M.D., F.A.C.P., Associate Professor of Medicine, Weill Medical College of Cornell and Director of Medical Ethics, New York Presbyterian hospital, prepared statement	101
Fishman, Scott M., M.D., Chief, Division of Pain Median and Associate Professor of Anesthesiology, University of California, Davis School of Medicine, prepared statement	104
Gilbert, John A. Jr., Hyman, Phelps & McNamara, PC, letter	91
Guest, James A., Executive Director, American Pain Foundation, prepared statement	98
Joranson, David E., Senior Scientist, Director of the Pain & Policy Studies Group, University of Wisconsin Comprehensive Cancer Center, prepared statement	105
Miech, Ralph P., M.D., Ph.D., Brown University School of Medicine, Dept. of Molecular Pharmacology, Physiology & Biotechnology, letter	96
National Association of Pro-Life Nurses, prepared statement	107
National Conference of Catholic Bishops, prepared statement	109
National Right to Life Committee, prepared statement	118
Oncology Nursing Society, prepared statement	118
Pain Care Coalition, prepared statement	119
Physicians for Compassionate Care, prepared statement	121
Rose, Harvey L., M.D., Board Certified Family Practitioner, prepared statement	126
Sparks, Robert M., letter	97
The Pain Relief Promotion Act	3
Vorenberg, James, Harvard Law School, letter	94

PAIN RELIEF PROMOTION ACT

TUESDAY, APRIL 25, 2000

U.S. SENATE,
COMMITTEE ON THE JUDICIARY,
Washington, DC.

The committee met, pursuant to notice, at 9:39 a.m., in room SD-226, Dirksen Senate Office Building, Hon. Orrin G. Hatch (chairman of the committee) presiding.

Also present: Senators Sessions and Grassley.

OPENING STATEMENT OF HON. ORRIN G. HATCH, A U.S. SENATOR FROM THE STATE OF UTAH

The CHAIRMAN. Today, the Judiciary Committee is holding a hearing on H.R. 2260, the Pain Relief Promotion Act. The Senate companion, S. 1272, was introduced by Senator Nickles of Oklahoma. We are happy to have Senator Nickles, Senator Wyden, and Senator Smith here, as well.

Similar legislation has been considered by this committee in the past. During the 105th Congress, the Senate Judiciary Committee held a hearing on S. 2151 and reported it to the Senate on September 24, 1998. In this Congress, the Pain Relief Promotion Act was passed by the House of Representatives on October 27, 1999, by a substantial 271 to 156 vote. In addition, the Senate HELP Committee held a hearing on this legislation late last year.

The Pain Relief Promotion Act has two main purposes. First, it encourages practitioners to prescribe and administer controlled substances to relieve pain and discomfort. Practitioners should be encouraged to treat pain aggressively even when the treatment may increase the risk of death. Almost every member of the committee has known someone who has confronted unbearable pain in the end-of-life situation, and we all understand that the medical community must be able to exercise certain discretion in ministering to those patients in these situations.

Title I of the bill instructs HHS through the Agency for Healthcare Research and Quality to undertake activities that will promote and advance scientific understanding of pain management and palliative care. This legislation states that alleviating pain with controlled substances in the usual course of medical practice is a legitimate medical purpose. Because pain treatment and palliative care are protected by a safe harbor is one reason why there is substantial support for this legislation from health care providers.

The second purpose of this legislation is to prevent the dispensing of controlled substances for causing death or assisting

someone in causing his or her death. This includes the practice of physician assisted suicide. I believe that this practice is abhorrent. The question of how people should conduct their lives when confronted by a terminal disease involves intensely personal moral and religious issues. The old and wise principle of, "first, do no harm," is irreconcilable with assisted suicide. I think the majority of the members of this committee agree with me.

In other words, aggressive pain management should be encouraged and assisted suicide using federally controlled substances should not be permitted under any circumstances. I do not think reasonable people have any difficulty discerning the difference.

Let us not forget why we are here. This bill simply tries to correct an erroneous, soft-headed interpretation of title 21 of the Controlled Substances Act. Attorney General Reno, with her eye on the Oregon law, reinterpreted an existing Federal statute in a fashion contrary to DEA Administrator Constantine, our nation's chief drug enforcement officer. Administrator Constantine had taken the traditional and legitimate view that the CSA does not permit controlled substances to be used to bring about assisted suicide or euthanasia. Unfortunately, the Attorney General chose to interpret the statute so that Oregon would be granted an exemption and, thus, Oregon's physicians would be allowed to use controlled substances while assisting in a suicide.

The irony of this decision is that even the President has signaled his opposition to the practice of assisted suicide. Through this legislation, the statute will be applied consistently to all 50 States. No exemptions will be granted just because a State like Oregon has approved an assisted suicide referendum.

But let me make it clear that this bill does not direct the DEA to launch a major investigatory initiative into the pain management arena. In fact, to address the concerns of health care providers, the substitute bill that I will offer during the committee's markup of H.R. 2260 contains a provision that is neither in the House bill nor the Senate companion bill.

The new provision, modeled on the legislation reported out of this committee during the 105th Congress, establishes the higher clear and convincing evidentiary standard for DEA administrative hearings involving allegations of assisted suicide or euthanasia. I know DOJ and DEA oppose this higher standard. However, when we completed our markup in 1998, I pledged to the members of this Congress, to Senators Leahy and Feinstein, that I would continue to work to see whether we could develop a broader consensus on this bill. I believe it is proper for Congress to make a strong statement about the need for state-of-the-art pain management and palliative care and to restore the original intent of our drug laws relative to assisted suicide.

Several groups who adamantly opposed a bill from the 105th Congress now support it. These groups include the National Hospice Organization, the Hospice Association of America, the American Academy of Pain Management, the American Society of Anesthesiologists, the Pain Care Coalition, and the American Medical Association. Without objection, I would like to include in the record a list of over 40 organizations and 20 prominent individuals.

[The information of the Chairman follows:]

THE PAIN RELIEF PROMOTION ACT

H.R. 2260 AND THE SUBSTITUTE AMENDMENT

Supporting Organizations

Aging With Dignity
 Agudath Israel of America
 American Academy of Pain Management
 American College of Osteopathic Family Physicians
 American Medical Association
 American Society of Anesthesiologists
 Americans for Integrity in Palliative Care
 Americans United for Life
 Association of Pain Management Anesthesiologists
 California Disability Alliance
 Catholic Health Association
 Catholic Hospice (Florida)
 Catholic Medical Association
 Christian Medical & Dental Society
 Coalition of Concerned Medical Professionals
 Eagle Forum
 Family Research Council
 Florida Hospices and Palliative Care, Inc.
 Florida Medical Association
 Focus on the Family Physicians Resource Council
 Friends of Seasonal and Service Workers (Oregon)
 Hope Hospice and Palliative Care (Florida)
 Hospice Association of America
 Iowa Medical Society
 Louisiana State Medical Society
 Lutheran Church-Missouri Synod
 Medical Association of the State of Alabama
 Medical Society of Delaware
 Medical Society of New Jersey
 Medical Society of the State of New York
 Michigan State Medical Society
 National Conference of Catholic Bishops
 National Hospice Organization
 National Legal Center for the Medically Dependent and Disabled
 National Right to Life
 Nebraska Coalition for Compassionate Care
 Not Dead Yet
 Oklahoma State Medical Association
 Pain Care Coalition
 American Academy of Pain Medicine
 American Headache Society
 American Pain Society
 Pennsylvania Medical Society
 Physicians for Compassionate Care
 Supportive Care of the Dying: A Coalition for Compassionate Care
 South Carolina Medical Association
 Union of Orthodox Jewish Congregations of America
 Virginia Association For Hospices
 Vitas Healthcare Corporation (CA, FL, IL, OH, PA, TX, WI)
 Wisconsin Council on Developmental Disabilities

Individual Endorsements

Lynne B. Bissonnette, M.D., Ph.D., Psychiatrist, Portland, Oregon
 James K. Boehnlein, M.D., M.Sc., Assoc Professor of Psychiatry, Oregon Health Sciences University
 Ira Byock, M.D., The Palliative Care Service
 Eric Chevlen, M.D., Director of Palliative Care, Cancer Care Center, St. Elizabeth's Medical Center, Youngstown, Ohio
 Carlos F. Gomez, M.D., Ph.D., Director, Palliative Care Service, University of Virginia, School of Medicine
 Dorothy W. Hagan, Ph.D. RD, LD, Director, Oregon Health Sciences University
 David Harris, M.D, OB-GYN, White Wilson Medical Center, Pennsylvania
 Catherine Hamilton, M.A., Counselor, Beaverton, Oregon

N. Gregory Hamilton, M.D., Portland, Oregon
 Herbert Hendin, M.D., Dir. of American Foundation for Suicide Prevention
 Dr. Walter Hunter, M.D., Vista Hospice
 C. Everett Koop, M.D., former U.S. Surgeon General
 Ralph P. Miech, M.D., Ph.D., Brown University School of Medicine
 Robert D. Orr, M.D., Director of Ethics, Loma Linda University Medical Center, &
 Chairman of California Medical Association's Council on Ethical Affairs
 Edmund D. Pellegrino, M.D., Georgetown University Medical Center
 Daniel L. Phillips, M.D., Eugene, Oregon
 Thomas M. Pitre, M.D., Northwest Urological Clinic, Portland, Oregon
 James P. Rathmell, M.D., Burlington, Vermont
 William E. Ryan, M.D., FACP, Pennington, New Jersey
 Robert J. Saxer, M.D., Fort Walton Beach, Florida
 Daniel Sulmasy, O.F.M., M.D., Ph.D. Professor of Medicine and Director of Bioethics
 Institute, New York Medical College
 William L. Toffler, M.D., Portland, Oregon

The CHAIRMAN. Finally, I want to thank all of our witnesses who have taken time out of their busy schedules to be with us today. I certainly appreciate all of your willingness to share your views with us on this important issue.

We are particularly happy to have three Senators here today who have interest in this bill, who have major interest in this bill. We are happy to welcome Senator Nickles, the majority whip in the U.S. Senate, Senator Wyden from Oregon, and Senator Smith from Oregon, both from the State that has handled a number of these problems.

We will turn to you, Senator Nickles, first, and then we will go to Senator Wyden and then Senator Smith.

**STATEMENT OF HON. DON NICKLES, A U.S. SENATOR FROM
 THE STATE OF OKLAHOMA**

Senator NICKLES. Mr. Chairman, thank you very much. I very much appreciate your opening statement. I appreciate the work that you have done on this issue. We have had hearings before your committee in the past. I also want to compliment you on your perfecting amendment to legislation that Senator Lieberman and myself have been working on now for 3 years. We have 42 cosponsors on this legislation, bipartisan support. My thanks to my colleague, Senator Lieberman, as well, for his leadership. As you mentioned, the House has previously passed this legislation by almost a 2-to-1 margin in the House.

Mr. Chairman, at this point, I will ask unanimous consent that my statement be inserted in the record.

The CHAIRMAN. Without objection.

Senator NICKLES. In addition, I would ask that a series of other things that I would like be included in the record: A statement that I made on November 18 in the Congressional Record on the effects of this bill; a DEA letter regarding the substitute amendment, which you may have included in your statement, I am not sure; a legal analysis on this bill; a letter from the American Medical Association in support of the bill; a Pain Care Coalition statement of support for the bill; and a couple of news articles, an editorial from the Oregonian, "A State's Rights and a State's Wrongs," it was October 19, 1999, and also a Wall Street Journal editorial, "Don't Kill the Pain Relief Bill," November 4, 1999.

[The information of Senator Nickles is attached to his prepared statement.]

Senator NICKLES. Mr. Chairman, we have been working on this bill for a long time and we need to pass it. A very similar measure passed this committee, I believe, by a vote of 11 to six in the last month or two of the session in 1998. We did not have time to get it worked through at that point.

But it also gave us more time to alleviate some of the concerns that some groups and organizations raised. You mentioned at that point, I believe the Hospice Association was opposed to the legislation. We have alleviated those concerns. They are now endorsing the legislation. The American Medical Association endorses this legislation. And it has been improved, and my compliments to you and your staff in working with our staff and others, I think making improvements to alleviate any concerns about this legislation from the negative standpoint.

This legislation is about two things. It is about alleviating pain. These are federally controlled substances. They are very strong. They can be deadly. They can alleviate pain, and we say by all means they should be used to alleviate pain, and these are controlled by the Federal Government. They have been controlled by the Federal Government since 1914. The Harrison Narcotics Act in 1914 controlled these very strong substances, further changed by the Controlled Substance Act in 1970. So they have been controlled.

That Act has been in existence for 30 years and it says that these very strong substances can be used for legitimate medical purposes. We state very clearly in the legislation and by your amendment, by the legislation that we have been working on, that alleviating pain is a legitimate medical purpose. Assisted suicide is not, never has been, should not be, and we will further clarify it that it is not. Assisted suicide is not a legitimate medical purpose.

That is really what the bill does. Let us make it possible to use these very strong drugs. Let us even encourage the use of these very strong drugs to alleviate pain. Let us make sure that these very strong drugs are not abused to kill someone. That is important. It should not be necessary.

Attorney General Reno made a mistake in the letter. She cannot change a statute by a letter. The statute is very clear. Let me just read one paragraph. You mentioned Mr. Constantine, who is head of the Drug Enforcement Agency. This is in his November 5, 1997, letter. He said, "My staff has carefully reviewed the number of cases, briefs, law review articles, and State laws regarding physician assisted suicide, including the documents referenced in your letter. In addition, my staff has conducted a thorough review of prior administrative cases in which physicians have dispensed controlled substances for other than legitimate medical purpose. Based on that review, we are persuaded that delivering, dispensing, or prescribing controlled substance with the intent of assisting suicide would not be under any current definition a legitimate medical purpose."

They did a lot of work. This was not a quick study. And he said, these drugs should be used to alleviate pain. They should not be used for assisted suicide. That is exactly right.

Now, one question, I notice my two friends and colleagues from Oregon are here and I am continually reading, well, this is a bill

to overturn Oregon's law. I have a couple of comments. This bill does not overturn Oregon's law, but let me be perfectly clear. Oregon does not have the right to pass a referendum or a statute that overturns Federal law. These are federally controlled substances. They have been controlled by the Federal Government since 1914. The Controlled Substance Act passed in 1970 and the Federal law says these can only be used for legitimate medical purposes, period, and that has never included assisted suicide.

So in reference to States' rights, and I think I am probably as big an advocate for States' rights as anybody in the Senate, I believe very strongly in States' rights. I have served in the State legislature. But a State does not have the right to overturn Federal law. The State of Oregon or the State of Oklahoma cannot pass a statute that says, we want to legalize cocaine or legalize heroin for any purpose. They cannot do it. They cannot do it.

You cannot do it and say, well, we are going to use these drugs for assisted suicide because we think it is fine. Oregon or any other State can have all the referendums they want on assisted suicide but they cannot change Federal statute, Federal law, the law of the land, law that has been in existence for 85 years and say, oh, well, these are okay. We are going to change Federal law for assisted suicide. You cannot do it.

So we try to clarify that. We clarify this bill very, very clearly. Use these very strong drugs to alleviate pain. We even put in a safe harbor for physicians. If the use of these drugs accelerates the fact that somebody might die earlier, as long as the purpose is to use it to alleviate pain, no problem. If the intent and purpose is to end someone's life, to participate in assisted suicide, and in your amendment, even strengthening the standard test. I am not going to complain about that, but the main intent should not be assisted suicide. If that is the case, it is not a legitimate medical purpose and therefore it should not be allowed.

With that, Mr. Chairman, I will just thank you for your work and your effort and I look forward to not only getting this through the committee but getting it through the Senate, as well.

The CHAIRMAN. Thank you, Senator Nickles.

[The prepared statement of Senator Nickles follows:]

PREPARED STATEMENT OF SENATOR DON NICKLES

Mr. Chairman, Senator Leahy and members of the Senate Judiciary Committee, I thank you for holding this hearing today and allowing me to come before you to speak on H.R. 2260, The Pain Relief Promotion Act, and the important implications it has for the treatment of pain and other end of life symptoms including clarifying the use of federally controlled substances by caregivers throughout the country. Senator Lieberman and I have offered identical legislation to address these issues, S. 1272 the Pain Relief Promotion Act. It is my understanding that today we will also be discussing the substitute amendment to H.R. 2260 which Chairman Hatch is offering to this legislation. This substitute amendment goes even further to ensure that the needs of patients who are suffering in pain and other distressing symptoms will be adequately treated. It does so without undermining the intent of the original legislation and I believe improves the original legislation to even more clearly address the role of the federal government regarding federally controlled substances.

It has been nearly three years since Senator Lieberman and I first offered legislation to make clear Congress' intent when it comes to employing federally controlled substances especially in end-of-life situations. That bill, the Lethal Drug Abuse Prevention Act, had 23 bipartisan cosponsors. A hearing was held on the bill in the Senate Judiciary Committee and it was passed out of the Committee by a vote of 11-6, on September 24, 1998. Identical legislation was also offered in the House by

Chairman Hyde which, following a hearing, passed out of the House Judiciary Committee. However, due to the few legislative days left in the session it was not brought to either the House or Senate floor.

Immediately following the close of session in 1998 we began work on new legislation to respond to the concerns of the medical community on the impact of the Lethal Drug Abuse Prevention Act. We started from scratch in re-drafting legislation with three goals: (1) Make clear under the Controlled Substances Act (CSA) the federal standard that no one can use federally controlled substances for assisted suicide, and do so without creating new regulatory authority; (2) promote a greater understanding of pain management and palliative care both in the medical community and the law enforcement community; (3) gain the support of the National Hospice Organization, and American Medical Association, who previously opposed the bill.

On June 23, 1999, Senator Lieberman and I introduced legislation that accomplished those three goals, S. 1272, the Pain Relief Promotion Act. First, it clarifies federal law on the use of controlled substances. The bill:

- Provides an additional “safe-harbor” for physicians by establishing, for the first time in federal law, that under the Controlled Substances Act the relief of pain and discomfort is a “legitimate medical purpose”, even if the large doses used in treating pain may increase the risk of death (sometimes called the principle double effect). However, the intentional use of these drugs to cause death or assist in causing death is not allowed.
- Restore the current federal policy against assisted suicide in 49 states to all 50 states.
- Provide for the education of federal, state, and local law enforcement personnel in how to better accommodate the appropriate and necessary use of controlled substances for pain and discomfort.

Second, the bill provides federal support for training and research. It:

- Establishes in the Agency for Healthcare Research and Quality (AHRQ) [pronounced “ark”], a program of “Palliative Care Research and Quality” to develop and advance scientific understanding of pain management and palliative care and make available that information.
- Provides in Health Research Services Act (HRSA) [pronounced “her-sa”], \$5 million per year for grants and contracts to medical schools, hospices and other sites to train physicians and other health practitioners in the treatment of pain and associated symptoms, especially at the end of life.

Third, it is supported by over 40 organizations including:

- American Medical Association, National Hospice Association, Hospice Association of America, American Academy of Pain Management, American Society of Anesthesiologists, American College of Osteopathic Family Physicians, Americans for Integrity in Palliative Care, Catholic Health Association, Physicians for Compassionate Care, Vitas Healthcare Corporation, National Right to Life, Christian Medical & Dental Society, Eagle Forum, Hope Hospice and Palliative Care (Florida), National Conference of Catholic Bishops, Union of Orthodox Jewish Congregations of America, Not Dead Yet, Oklahoma State Medical Association, and Aging With Dignity.

The House and Senate both have taken action on the Pain Relief Promotion Act. In the House, hearings were held in the House Judiciary Committee, the bill was passed out of both the House Judiciary Committee and House Commerce Committee, and on October 27, 1999, the bill was passed in the House by a vote of 271–156. In the Senate a hearing was held in the Health, Education, Labor and Pensions Committee on October 13, 1999. Following passage of H.R. 2260 in the House, the bill was referred to the Senate Judiciary Committee. Today we are again meeting to hear testimony on this bill and the substitute amendment to be considered. It is my hope that this will be the final hearing on this issue and the bill will be passed out of the Judiciary Committee and sent to the Senate floor where it will be debated, passed, and signed into law.

It is essential that Congress does not remain silent. Congress has acted with one voice previously to ensure that no federal program, facility or employee is involved in assisted suicide. Enactment of the Pain Relief Promotion Act will ensure that federal authorization to prescribe DEA-regulated drugs does not include the authority to prescribe such drugs to specifically cause a patient’s death.

Since 1914, the federal government has had jurisdiction over dangerous drugs. In 1970 Congress passed the Controlled Substances Act (CSA) which gave responsibility for such substances to the Drug Enforcement Administration (DEA) and charged them with the responsibility of overseeing these narcotics and dangerous drugs. The CSA states that these federally controlled drugs can only be prescribed

for a “legitimate medical purpose” and only by a physician who has a DEA registration. It is important to understand that while a physician receives his license to practice from state medical boards, he receives a separate DEA registration to prescribe federally controlled substances from the federal government. In 1984 Congress strengthened the CSA out of concern over the use of prescription drugs in lethal overdoses. Nowhere in the history of the Controlled Substances Act has death ever been considered a “legitimate medical purpose.” However, on June 5, 1998, Attorney General Janet Reno issued a decision which overturned the previous DEA ruling that assisted suicide, intentionally causing a patient’s death, was not a legitimate medical purpose and therefore federally controlled substances could not be used for that purpose. The Attorney General concluded the Controlled Substances Act does not authorize adverse action against a physician who prescribes a controlled substance to assist in a suicide in compliance with the Oregon law. She stated that Congress did not “intend to override a state determination as to what constitutes legitimate medical practice in the absence of a federal law prohibiting that practice.”

The Attorney General failed to point out that federal law is clearly intended to prevent the use of these drugs for lethal overdoses, and contains no exception for deliberate overdoses approved by a physician. Nor does that law contain any exception for giving dangerous drugs to terminally ill patients—on the contrary, the federal government has successfully argued before the Supreme Court against allowing any such loophole in its drug laws. Every federal agency, health program, health care facility and health professional is forbidden to treat assisted suicide as though it were part of legitimate medical practice. Also, President Clinton maintains his longstanding position against assisted suicide and any federal support for that procedure.

In spite of the Attorney General’s determination the fact is that federally controlled substances are exactly that . . . federally controlled. Under present federal law, the Controlled Substances Act, these federally controlled substances can only be prescribed for a “legitimate medical purpose” in the usual course of professional practice, to promote public health and safety. A lethal overdose, otherwise known as assisted suicide, has never been considered a legitimate medical purpose and certainly does not promote public health and safety.

When Oregon passed a state law to allow physician assisted suicide, it had that right. But it did not have the right to change or amend an existing federal law. If Oregon were to legalize the use of heroin for any purposes that wouldn’t change the federal law prohibiting its use. The Controlled Substances Act is a federal law governing all 50 states, not 49.

The Attorney General’s letter carving out an exception for Oregon to use federally-controlled substances for assisted suicide was in direct opposition to her own Drug Enforcement Administration and is also in direct conflict with 29 years of practice under the Controlled Substances Act. Present law states these drugs can be used only for a “legitimate medical purpose.” The Pain Relief Promotion Act makes clear, for the first time, that aggressive treatment of pain is a legitimate medical purpose and provides new legal protections, and additional safe harbor, for physicians to use these medications to alleviate pain and discomfort. It also restates that the use of these federally controlled drugs to cause death or assist in causing death is not a legitimate medical purpose. The Pain Relief Promotion Act does not overturn any state law. The bill does not tell States they can’t pass their own laws on assisted suicide—they can—it just clarifies that those State laws have no effect on this long standing federal law.

The substitute amendment offered by Chairman Hatch goes even further to clarify that the bill will neither pre-empt state laws or standards for pain management and palliative care, nor allows states to pre-empt Federal law regarding controlled substances. It also clarifies that the Attorney General does not have the authority to create federal standards (dosage requirements) for the practice of pain management and palliative care. It makes certain that all types of pain including acute, chronic, and end-of-life, can be addressed in the education, research, and grant programs for pain management and palliative care. Additionally, it highlights the importance of pain management and palliative care by declaring the decade beginning in 2001 the “Decade of Pain Control and Research.”

The Pain Relief Promotion Act has strong bipartisan support with currently, 42 cosponsors. In addition to the underlying support for the bill the AMA has reaffirmed their support for the substitute amendment and the Pain Care Coalition (made up of the American Pain Society, American Academy of Pain Medicine, and American Headache Society) has confirmed their support for the substitute. The Pain Relief Promotion Act and the Chairman’s substitute amendment gets the federal government back in the business of caring for people in pain rather than par-

ticipating in causing their death. To date, over 42 people in Oregon have died using federally controlled substances to cause their death. It is time the federal government ends its involvement in this tragedy. The Pain Relief Promotion Act is good for physicians, it is good for patients and it is necessary to restore the federal law.

I ask your support for this bill and the substitute amendment, and I thank you for the opportunity to appear before you this morning on this critical issue.

STATEMENT BY SENATOR DON NICKLES ON S. 1272, THE PAIN RELIEF PROMOTION
ACT

November 18, 1999

On June 23, 1999, Senator Lieberman and I introduced S. 1272, the Pain Relief Promotion Act, which addresses two specific concerns. First, it provides federal support for training and research in palliative care. Second, it clarifies federal law on the legitimate use of controlled substances. On October 27, 1999 the House passed its companion measure H.R. 2260 by the resounding bipartisan vote of 271 to 156. It is my hope that the Senate will soon have the opportunity to debate and vote on this important legislation.

In anticipation of that debate, and in light of inaccurate characterizations of the second aspect of our bipartisan legislation, I believe it is important for me to ensure that the Record reflects precisely how this bill will—and will not—affect current federal law with regard to Drug Enforcement Administration (DEA) oversight of the use of federally controlled substances.

To understand the effect the Pain Relief Promotion Act will have on pain control, we must begin with what the law is now. The Controlled Substances Act (CSA) of 1970 charged the DEA with the responsibility of overseeing narcotics and dangerous drugs—including powerful prescription drugs which have a legitimate medical use but can also be misused to harm or kill. In asserting its authority over these drugs, Congress declared in the preamble of the Controlled Substances Act of 1970 that “Federal control of the intrastate incidents of the traffic in controlled substances is essential to the effective control of the interstate incidents of such traffic” (21 USC 801(6)).

In 1984, Congress amended the CSA due in part to a specific concern regarding the misuse of prescription drugs in lethal overdoses. The then Democratic-controlled House and a Republican Senate further strengthened the Act, empowering the DEA to revoke a physician’s federal prescribing license if he or she uses it to endanger “health and safety” regardless of whether the state law has been violated (21 USC 824, referencing 21 USC 823). The chairman of the Health subcommittee in the House agreed: “Drugs legally manufactured for use in medicine are responsible for a substantial majority of drug-related deaths and injuries” (Rep. Waxman, Hearing of July 31, 1984, Hearing Record No. 98-168, p. 365). Congress’s view was that while the states are the first line of defense against misuse of prescription drugs, the federal government must have its own objective standard as to what constitutes such misuse—and it must have the authority to enforce that standard when a state cannot or will not do so. Congress’s 1970 and 1984 decisions have been upheld time and time again by federal courts.

It is clear that federal law is intended to prevent use of these drugs for lethal overdoses, and contains no exception for deliberate overdoses approved by a physician. Nowhere in the Controlled Substances Act has death or assisting death ever been considered a “legitimate medical purpose” for use of these drugs. In the past, physicians who were involved in the use of these drugs for suicide or other lethal overdoses have lost their federal authority to prescribe controlled substances on the grounds that they had endangered “health and safety.”

In 1997, Congress passed the Assisted Suicide Funding Restriction Act of 1997 without a dissenting vote in the Senate and by an overwhelming margin of 398-16 in the House. President Clinton stated in signing the bill that “it will allow the Federal Government to speak with a clear voice in opposing these practices.” He further warned that “to endorse assisted suicide would set us on a disturbing and perhaps dangerous path.” I would add only that authorizing a federal agency to endorse the use of controlled substances for assisted suicide would similarly “set us on a disturbing and perhaps dangerous path.”

In November 1994, the State of Oregon adopted by referendum the so-called “Death with Dignity Act,” allowing physicians to prescribe medication for the purposes of assisting patients’ suicides. The week of that vote, Professor George Annas of Boston University pointed out the inconsistency between the Oregon referendum and the Controlled Substances Act in an article in the *New England Journal of*

Medicine. He questioned whether such a state law was compatible with existing federal laws governing federally controlled drugs, "since the drafters of the federal statute certainly did not have this purpose [assisting suicides] in mind."

However, on June 5, 1998, overturning a previous determination by her own DEA Administrator, the Attorney General issued a letter carving out an exception for Oregon so it can use federally-controlled substances for assisted suicide. She claimed that Congress did not "intend to override a state determination as to what constitutes legitimate medical practice in the absence of a federal law prohibiting that practice." The Pain Relief Promotion Act will respond to the Attorney General's challenge, by clarifying that the intentional misuse of these drugs to cause patients' deaths is not authorized by Congress in any state, nor has it ever been.

On October 27, 1997, Oregon's "Death with Dignity Act" became effective. In the first year at least 15 patients have committed suicide with doctor's assistance under the new Oregon law. We really do not know the total number, because all reporting of cases is left completely in the hands of the doctors themselves, and the Oregon Health Division admits it has no idea how many unreported cases there are. But regarding those 15 reported cases we know one thing: Every one of those patient's' deaths was caused by a federally controlled substance, prescribed with a federal DEA registration number, using federal authority. Today, without any decision to this effect by Congress or the President, the federal government is actively involved in assisting suicides in Oregon.

To hear some of the critics of this bill you might think that the Pain Relief Promotion Act creates a new authority on the part of the DEA to revoke doctors' registrations if they use controlled substances to assist suicide. On the contrary that authority has existed for 29 years and it exists now. Attorney General Janet Reno was very clear on this matter in her letter of June 5, 1998: "Adverse action under the CSA may well be warranted . . . where a physician assists in a suicide in a state that has not authorized the practice under any conditions, or where a physician fails to comply with state procedures in doing so."

What does this mean for current law and practice? First, the DEA has full authority to revoke a DEA registration for assisting suicide in any of the 49 states where assisting suicide is not authorized by state law. While critics of the Pain Relief Promotion Act have said that empowering the DEA to investigate physicians in such cases will have a "chilling effect" on the treatment of pain, the fact is that such authority already exists in 49 states.

What about the one state, Oregon, where the Attorney General said the DEA will not take adverse actions against physicians for assisting suicide in compliance with the Oregon law? Even in Oregon many cases of assisting suicide remain illegal under state law. The state law authorizes assisting the suicide of those who are terminally ill, but not others. Under the Attorney General's determination, then, the DEA can continue to review cases of assisting suicide to make sure they do not involve those who are not terminally ill, and it can scrutinize whether a given use of pain medication was really intended to assist suicide. All aspect of the Oregon guidelines for legally valid assisted suicide are also subject to DEA investigation, since the Attorney General has only authorized physicians to use federally controlled drugs for assisted suicides when they fully comply with those state guidelines.

Thus, as interpreted by the Attorney General, a registration to prescribe federally controlled substances can be revoked under the current Controlled Substances Act if these substances are used to assist suicide in any state in the Nation, with the exception of certain cases of assisted suicide that Oregon has legalized for the terminally ill. If DEA scrutiny of doctors' prescribing practices were going to "chill" the practice of pain control, that would already be occurring under current law.

How does the Pain Relief Promotion Act impact this situation? It establishes that, for the first time in federal law, the use of controlled substances for the relief of pain and discomfort is a "legitimate medical purpose," even if the large doses used in treating pain may unintentionally hasten death. Intentionally causing death or assisting in causing death remains forbidden. Thus this bill does not increase the DEA's regulatory authority at all. On the contrary, its only effect in 49 states (and even in Oregon, in cases involving those who are not terminally ill) is to provide new legal protection for physicians who prescribe controlled substances to control pain.

In Oregon, this bill eliminates the Attorney General's artificial exception designed to accommodate assisted suicides that are no longer penalized under Oregon law. The DEA can meet its responsibility here simply by looking at the reports required by Oregon law, in which doctors must identify the drugs used to assist suicide. Those records will make it clear whether federally controlled drugs were used; and since the physician is clearly reporting that his or her own intent was to help cause

death, there will be no question of murky intentions or ambiguity. Thus this bill will not lead to any increase in the DEA trying to “second guess” or infer physicians’ intentions, even in Oregon.

What of any unreported cases in which physicians assist the suicides of terminally ill patients? Those assisted suicides are already a crime under Oregon law, and thus already subject to adverse action by the DEA as well under the Attorney General’s interpretation. Only if a physician officially reports the case to the Oregon Health Division is he or she exempted from state criminal penalties. So those cases are already covered by the same DEA authority that currently applies to assisted suicides in the other 49 states.

Let me take this situation step by step.

First, removing the Oregon exception to the existing nationwide policy cannot increase any “chilling effect” on pain relief outside of Oregon, because the bill does not increase one iota the authority of the DEA to investigate the misuse of controlled substances to assist suicide outside of Oregon. In fact, in those states its only effect is to provide a more explicit “safe harbor” for the practice of pain control, which is a significant advance and improvement for doctors and terminally ill patients. This is also true of assisted suicide cases within Oregon that do not comply with the state’s reporting requirements or other guidelines. In all these cases, the Pain Relief Promotion Act gives the DEA no new mandate to investigate cases of assisted suicide more directly. Rather, it is expected to follow its longstanding practice of generally deferring to state authorities and allowing them to take the lead in investigating possible wrongdoing.

Second, no new questioning of physicians’ intentions is warranted to address the cases of assisted suicide that are now permitted under Oregon law. To be free of criminal penalties under state law in Oregon, a doctor who assists a suicide must submit a report to Oregon authorities that includes information on the drugs prescribed to assist the suicide. The Drug Enforcement Administration (DEA) can obtain those reports from the Oregon authorities. It already has the authority to subpoena them, if necessary; again, our legislation has no impact on this.

Thus, even in Oregon, this bill will not result in any increase in DEA oversight or investigations of doctors based on their prescribing patterns or the dosages they use for particular patients. This is clearly stated in the House Judiciary Committee report on this bill, H. Rep. 106–378 Pt. 1, pp. 12–13.

It follows that if this bill is enacted, any doctors in Oregon who prescribe controlled substances for pain relief need not fear any increase in DEA scrutiny of their practices, and therefore should not in any way be deterred from prescribing adequate pain relief.

This bill cannot have a “chilling effect” on pain control, but will have the opposite effect. For the first time, it will place in the Controlled Substances Act, as the American Society of Anesthesiologists notes, “recognition that alleviating pain in the usual course of professional practice is a legitimate medical purpose for dispensing a controlled substance that is consistent with public health and safety, even if the use of such a substance may increase the risk of death.” The American Medical Association says this bill, “provides a new and important statutory protection for physicians prescribing controlled substances for pain, particularly for patients at the end of life.” As the American Medical Association of Pain Management observes, this will protect the ability of “prescribers to relieve pain without fear of regulatory discipline.”

Those who are concerned about the possibility of a negative impact on pain relief if we pass this bill need to answer this question: do they believe that NOW the Drug Enforcement Administration is having a chilling effect on pain relief because federally controlled substances cannot be used to assist suicide in 49 states and even, in many cases, in Oregon?

If the answer is “no,” then there is no basis to be concerned about this bill—for this bill will not increase investigations or oversight into the dosages of drugs used for pain relief, and in fact instructs the DEA to be even more sensitive to physicians’ need to prescribe large doses of these drugs for pain control.

If the answer is “yes,” then there is a great need for this bill—because for the first time it adds specific protections for doctors who prescribe controlled substances for pain control—resulting in a decrease in any “chilling effect” that may exist under current law.

Let me quote from the American Medical Association. “The bill would not expand existing criminal penalties in the CSA for persons whose unauthorized use of a controlled substance leads to someone’s death. . . . The bill would not expand the DEA’s authority concerning jurisdiction, investigations or enforcement regarding the CSA. In fact, the inclusion of a recognition of the ‘double effect’ in the CSA provides physicians in all jurisdictions an additional statutory protection in cases of alleged

[physician-assisted suicide]. The bill has the potential, through its educational provisions, of sensitizing law enforcement personnel to the multiple issues of end-of-life care and prescribing.”

It is noteworthy that although the Justice Department expressed concern about the portion of the bill that would prevent the use of federally controlled substances to assist suicide in Oregon, it agrees that the bill would aid, and not hinder, pain relief. In a letter dated October 19, 1999, the Justice Department wrote that the bill “would eliminate any ambiguity about the legality of using controlled substances to alleviate the pain and suffering of the terminally ill by reducing any perceived threat of administrative and criminal sanctions in this context. The Department accordingly supports those portions of [the bill] addressing palliative care.”

This bill makes it easier, not harder, to use controlled substances to relieve pain. That is why so many major medical organizations, including the National Hospice Organization, the American Academy of Pain Management and the American Society of Anesthesiologists, as well as the AMA, strongly support its enactment.

Some may wish to abolish the Controlled Substances Act altogether. They may think that the federal government’s longstanding insistence on monitoring the distribution of these powerful drugs is an unwarranted intrusion into medical practice. I disagree with that stand, but at least it can be understood as a consistent position. What is untenable is the claim that this particular bill, which clearly improves the law’s sensitivity to medical judgments on pain control, somehow mysteriously worsens that situation. Once we understand what the current law is and what this bill does, that claim simply does not make sense.

In short, the Pain Relief Promotion Act will foster pain control. It will improve existing law by adding significant new legal protections for physicians and pharmacists who prescribe and dispense controlled substances for pain control. It will reduce, and in no way increase, any possible “chilling effect” that could deter adequate pain control. And by clarifying federal law so the federal government will not facilitate the medical institutionalization of assisted suicide in any state, this legislation may help discourage doctors from simply suggesting assisted suicide instead of working to address their patients’ real problems of uncontrolled pain. As protectors of public health and safety we should be encouraging doctors to kill the pain, not the patient.

DRUG ENFORCEMENT ADMINISTRATION,
Washington, DC, April 5, 2000.

Hon. ORRIN G. HATCH,
*Chairman, Committee on the Judiciary,
U.S. Senate, Washington, DC.*

DEAR CHAIRMAN HATCH: This is in response to your request for the position of the Drug Enforcement Administration (DEA) on a proposed amendment to the Pain Relief Promotion Act of 1999, H.R. 2260. This amendment would raise the burden of proof in administrative hearings involving physician-assisted suicide from the preponderance-of-the-evidence standard to a clear-and-convincing evidence standard. DEA opposes this amendment.

The imposition of the clear-and-convincing evidence standard would be an abrupt departure from the standard of proof that has always been applied in administrative cases under the Controlled Substances Act (CSA). Starting with the enactment of the CSA in 1970, and continuing to the present, Congress has mandated that proceedings to deny, revoke, or suspend registration be conducted in accordance with the Administrative Procedure Act (APA). Under the APA, the preponderance-of-the-evidence standard is to be applied in administrative proceedings. *Steadman v. S.E.C.*, 450 U.S. 91 (1981). This standard, along with the other procedural safeguards contained in the APA, has been in effect for more than 50 years. DEA finds no reason to depart now from this traditional approach.

DEA does not support the concept of applying different evidentiary standards depending on the nature of the particular administrative case, which is inherent in the proposed amendment. DEA believes that the preponderance-of-the-evidence standard should continue to be applied uniformly in all administrative cases. See 21 U.S.C. §§ 823(f), 824(a) (listing factors to be considered for denial or revocation of registration).

Even in Oregon (the only state that expressly authorizes physician-assisted suicide), the preponderance-of-the-evidence standard applies in state medical licensing proceedings. See *Gallant v. Board of Medical Examiners*, 159 Or.App. 175 (1999). This illustrates how the APA standards properly remain the model for administrative proceedings throughout the nation. H.R. 2260 does not alter the long-standing

federal requirement that controlled substances be dispensed only for a legitimate medical purpose by a practitioner acting in the usual course of professional practice. The bill simply makes clear that, in determining whether a registration is consistent with the public interest, the Attorney General (and DEA, by designation) “shall give no force and effect to State law authorizing assisted suicide or euthanasia.” Since Oregon is the only state with a law permitting assisted suicide, DEA’s authority to take administrative action in every other state would not be changed by H.R. 2260.

There is no foundation to the allegations that if H.R. 2260 were enacted DEA would seize the opportunity to investigate patient deaths. It has always been state and local authorities who take primary responsibility for investigating suspicious deaths. DEA has no plans—and lacks the resources or expertise—to take this role from the state and local authorities.

I also wish to comment briefly on the pain treatment aspect of H.R. 2260. As indicated in the bill, the issue of pain treatment is distinct from the issue of physician-assisted suicide. I agree with and support the provision of the bill which specifies that the dispensing of a controlled substance to alleviate pain or discomfort in the usual course of professional practice is a legitimate medical purpose, even if the use of such substance may increase the risk of death.

I understand that there are some who have made the claim that this law will make practitioners reluctant to dispense controlled substances in the quantities required to properly treat pain. I want to emphasize that DEA fully supports the effective treatment of pain. This is clearly demonstrated by the fact that DEA has dramatically increased the annual quotas for pain medications over the past ten years. During this period, the morphine quota has been increased by a factor of 2.5, fentanyl by a factor of 7.75, oxycodone by a factor of 3, hydromorphone by a factor of 3.3 and hydrocodone by a factor of 3. In addition, DEA has worked actively with the Federation of State Medical Boards in its development of the Model Guidelines for the Use of Controlled Substances for the Treatment of Pain. These guidelines were adopted on May 5, 1998 and DEA fully supports them. I am concerned by statements indicating that some groups do not understand our position on pain relief. Members of my staff are available to meet with representatives of these groups to discuss this critical health care issue.

If you have any additional questions, please contact me at (202) 307-8000.

Sincerely,

DONNIE R. MARSHALL, *Acting Administrator*.

VERNER, LIIPFERT, BERNHARD, MCPHERSON AND HAND,
Washington, DC, February 9, 2000.

THE PAIN RELIEF PROMOTION ACT (S. 1272) INTRODUCED BY SENATOR DON NICKLES

I. OVERVIEW: PAIN RELIEF ACT

The Pain Relief Promotion Act of 1999 (“Pain Relief Act”), S. 1272, introduced by Senator Nickles, amends the Controlled Substances Act (the “CSA”), 21 U.S.C. §§ 801-971. The bill (1) explicitly provides that controlled substances may be used for pain management and palliative care; (2) clarifies existing federal standards concerning assisted suicide and the use of controlled substances under the CSA, but does not create any new federal standard; and (3) overrides reliance on Oregon’s Death With Dignity Act (Or. Rev. Stat. §§ 127.800-127.995 (1997), the “Oregon Act”) and any other similar state law as a defense to any action under the CSA related to assisted suicide.¹

II. CONTROLLED SUBSTANCES ACT

The Controlled Substances Act provides authority for the Attorney General of the United States to register and if appropriate revoke the registration of manufacturers and distributors of certain controlled substances “consistent with the public interest.” 21 U.S.C. § 823 et seq. The Attorney General exercises her authority through the Drug Enforcement Administration (“DEA”), 21 C.F.R. 1301.01(b)(3). In determining the public interest, the Attorney General shall consider, *inter alia*, the following factors: the use of controlled substances for “legitimate medical purposes,” “compliance with applicable State and local law,” and other factors relevant to “public health and safety.” 21 U.S.C. § 823 et seq.

¹This memorandum examines the key elements of the Pain Promotion Relief Act, as noted, and does not specifically analyze other provisions such as those for education and training programs.

III. THE PAIN RELIEF ACT ALLOWS CONTROLLED SUBSTANCES TO BE USED FOR
PALLIATIVE CARE

There is no provision in the current CSA that expressly protects the use of controlled substances for palliative care, that is a drug or medical treatment which relieves suffering without treating the cause of the suffering (21 U.S.C. § 802 (defining controlled substance)). The Pain Relief Act includes an explicit provision providing that, under the CSA,

. . . alleviating pain or discomfort in the usual course of professional practice is a legitimate medical purpose for the dispensing, distributing, or administering of a controlled substance that is consistent with public health and safety, even if the use of such a substance may increase the risk of death.

S. 1272, § 101 (first sentence of new paragraph 823(i)(1)).

This provision provides, in essence, a “safe harbor” for those who dispense controlled substances for palliative care. It states clearly that, for purposes of applying the CSA’s public interest standard, aggressive treatment of pain and discomfort is a legitimate medical purpose even if it increases a patient’s risk of death. Recognizing the clear intent to provide a legal safe harbor, the Department of Justice (DOJ) has stated that the Pain Relief Act:

. . . would eliminate any ambiguity about the legality of using controlled substances to alleviate the pain and suffering of the terminally ill by reducing any perceived threat of administrative and criminal sanctions in this contact.²

IV. THE PAIN RELIEF ACT DOES NOT CREATE A NEW FEDERAL STANDARD PERTAINING
TO ASSISTED SUICIDE

The Pain Relief Act, as noted in the section above, establishes a new safe harbor that allows the dispensing of controlled substances for the purpose of alleviating pain and discomfort even if it increases the risk of death.

The next sentence in the same paragraph then sets forth a limitation to the safe harbor. The Act provides:

Nothing in this section authorizing intentionally dispensing, distributing, or administering a controlled substances for the purpose of causing death or assisting another person in causing death.

S. 1272, § 101 (second sentence of new paragraph 823(i)(1)).

The second sentence, as drafted, clarifies that the safe harbor should not be misinterpreted to provide a new federal standard to authorize assisted suicide.³ In other words, as drafted, the sentence only states what the section does not do (that is, to authorize assisted suicide). The sentence does not purport to add any new prohibition.⁴

²See letter from Robert Raben, Assistant Attorney General, Department of Justice, dated October 19, 1999, to The Honorable Henry J. Hyde (commenting on identical language in House legislation, H.R. 2260).

³Statutes, including state laws dealing with end-of-life issues, often use a similar construct to allow an activity but then limit its interpretation. For example, the State of Washington, which has a statute prohibiting assisted suicide, Wash. Rev. Code § 9A.36.060 (1994), passed a Natural Death Act which specifically states that the “withholding or withdrawal of life-sustaining treatment . . . shall not, for any purpose, constitute a suicide.” Then, to ensure that this permissible activity is not misinterpreted, the statute provides that “nothing in this chapter shall be construed to condone, authorize, or approve mercy killing . . .” Natural Death Act, RCW § 70.122.100. See *Washington, v. Glucksberg*, 117 S. Ct. 2258 (1997), upholding the constitutionality of Washington’s statute prohibiting assisted suicide. Like the federal bill (S. 1272) at issue here, the proviso in the Washington Natural Death Act that it does not authorize mercy killing only serves to limit the interpretation of the permissible activity, it does not provide a new state standard. For other state statutes with similar constructs, see S.C. Code § 44-77-130 (1999); 63 Okla. Stat. tit. 63, § 3101.12(G) (1999); Neb. Rev. Stat. Ann. § 20-412(7) (1999); 755 Ill. Comp. Stat. 40/50 (1999); Cal. Code § 7191.5 (Deering 1999); Ark. Code Ann. § 20-7-210 (1999).

⁴If the authors of the legislation had intended to provide a new federal statute prohibiting the use of controlled substances in assisted suicide, they clearly could have done so by using prohibitive language. Furthermore, if Congress intends to prohibit physician-assisted suicide entirely, it could do so directly by enacting legislation making it a federal crime. There is no fundamental right to commit or help another to commit suicide. See *Washington v. Glucksberg*, 117 S. Ct. 2258 (1997).

The purpose and plain reading of this language is to provide that the legislation does not add any new federal standard on assisted suicide.⁵

Revisions to Legislation Indicate Intent Not To Create New Federal Standard Regarding Assisted Suicide

A careful comparison of the language in the Pain Relief Act, introduced in the 106th Congress, and similar legislation considered in the 105th Congress is further evidence of the authors' intent not to add any new federal standard on assisted suicide. Indeed, the changes were made in direct response to concerns raised about the legislation from the earlier Congress.

The legislation considered in the 105th Congress (H.R. 4006 and S. 2151) affirmatively provided that the Attorney General may suspend or revoke registration under the CSA upon a finding that the registrant.

. . . has intentionally dispensed or distributed a controlled substance with a purpose of causing, or assisting in causing, the suicide or euthanasia of any individual, except that this paragraph does not apply to the dispensing or distribution of a controlled substance for the purpose of alleviating pain or discomfort (even if the use of the controlled substance may increase the risk of death), so long as the controlled substance is not also dispensed or distributed for the purpose of causing, or assisting in causing, the death of an individual for any reason.

H.R. 4006, § 2(b)(1); S. 2151, § 3(b)(1).

This section could have been understood to provide a new affirmative federal standard that a registration may be revoked if the physician has assisted in a suicide using controlled substances governed by the CSA. The language then, in a potentially confusing manner, modified this new standard by stating that it would not apply if the use of the controlled substances was for the purpose of alleviating pain or discomfort (even if increasing the risk of death) so long as it was not for the purpose of causing or assisting death.

By contrast, the Pain Relief Act introduced in the 106th Congress, as described above, was completely redrafted to avoid creating a new federal standard. Instead, the new legislation first provides a safe harbor for the use of controlled substances in palliative care, and only then carefully limits the application of the safe harbor without creating any new federal standard on assisted suicide.

V. FEDERAL GOVERNMENT HAS AN ESTABLISHED ROLE WITH RESPECT TO PHYSICIAN-ASSISTED SUICIDE

The federal government already has an established role and has articulated policies with respect to physician-assisted suicide. As detailed in the Solicitor General's amicus brief in *Washington v. Glucksberg* there are various federal policies relating to physician-assisted suicide in governmental institutions and "no Federal law . . . either authorizes or accommodates physician assisted suicide."⁶ Over the past two decades, there have been a series of federal cases and congressional acts relating to physician-assisted suicide. In particular, Congress adopted amendments to the CSA in 1984 that expand the grounds on which the Attorney General may revoke a practitioner's registration to dispense or conduct research with controlled substances, to include instances where registration would be "inconsistent with the public interest." 21 U.S.C. § 824(a)(4). This federal public interest standard has been applied by the DEA to cases in which physicians prescribed drugs used in suicides in numerous instances. Since 1980 the DEA has brought hundreds of enforcement actions against registrants for violating the federal legal standard of "legitimate medical purpose." See, e.g., 60 Fed. Reg. 56,354 (1995),⁷ 55 Fed. Reg. 4250 (1990),⁸

⁵As described in this section S. 1272 does not provide any new federal standard relating to physician-assisted suicide under the CSA. Accordingly, individuals covered by the CSA would not be subject to any new liability for violations of it—with the exception of those who would have relied on the Oregon Act as a defense to alleged violations of the CSA. See *infra* Section VI.

⁶Brief for the United States as Amicus Curiae Supporting Petitioners at 2, *Washington v. Glucksberg*, 117 S. Ct. 2258 (1997) (N. 96–110).

⁷Physician prescribed a potentially lethal amount of Darvocet to a depressed patient who used State law. His DEA application was denied on the separate basis that his conduct threatened "public health and safety."

⁸State Board suspended physician's medical license and his registration was revoked after patient under his care died from a methadone overdose. DEA determined that physician violated the CSA and demonstrated conduct which may further threaten "public health and safety."

55 Fed. Reg. 5306 (1990),⁹ 59 Fed. Reg. 46063 (1994).¹⁰ The Pain Relief Act does not expand the DEA's current investigative or enforcement authority.¹¹

In addition, in 1997 Congress adopted the Assisted Suicide Funding Restriction Act ("ASFRA"), which provides that no federal funds may be used, directly or indirectly, to provide any health care item or service furnished for the purpose of causing or assisting in causing the death of any individual, such as by assisted suicide, euthanasia, or mercy killing and forbids using federal funds to advocate or promote their legalization. 42 U.S.C. §§ 14401–14408. President Clinton emphasized that it "will allow the Federal Government to speak with a clear voice in opposing these practices," and cautioned that "to endorse assisted suicide would set us on a disturbing and perhaps dangerous path."¹²

In several rulings, the Supreme Court has also discussed physician-assisted suicide under federal law. See *Washington v. Glucksbert*, 117 S. Ct. 2258 (1997), *United States v. Rutherford*, 442 U.S. 544 (1979) (addressing federal drug law policy to protect the terminally ill from potentially lethal drugs); see also *Vacco v. Quill*, 117 S. Ct. 2293 (1997) (addressing physician's intent in physician-assisted suicide cases).

As a result of these congressional acts and federal cases, there is now an extensive history with respect to a federal role and federal policies concerning physician-assisted suicide.

DOJ Interpretation of Physician-Assisted Suicide Under Existing Controlled Substances Act

The Attorney General has recognized that the DEA already has the authority to prevent the abuse of controlled substances for assisted suicide. The Department of Justice ("DOJ") has indicated, however, that adverse action may not be taken under the Controlled Substances Act, 21 U.S.C. §§ 801–971, against a physician who has assisted in a suicide in full compliance with the Oregon Act ("Reno Letter" or "DOJ Opinion").¹³

In reaching this conclusion, the DOJ discusses *existing* federal law with respect to a physician who has assisted in a suicide *both in Oregon and in states without a law comparable to the Oregon Act*. In both cases, the DOJ describes an existing federal role in analyzing the propriety of the doctor's action.

Attorney General Reno states, in her letter,

* * * the CSA does not authorize [the Drug Enforcement Administration ("DEA")] to prosecute, or to revoke the DEA registration of, a physician who has assisted in a suicide *in compliance with Oregon law*. We emphasize that our conclusion is limited to these particular circumstances. *Adverse action under the CSA may well be warranted in other circumstances: for example, where a physician assists in a suicide in a state that has not authorized the practice under any conditions, or where a physician fails to comply with state procedures in doing so.* (emphasis added).

First, according to this statement, the DEA (that is, a federal governmental entity) must, in applying the CSA to physicians in a state such as Oregon, with a statute permitting physician-assisted suicide, determine whether "the physician fails to comply with the state procedures" in assisting in the suicide.

⁹Physician prescribed Percodan for non-medical purpose to several drug addicts, including one woman who overdosed on the prescribed drugs. In revoking his registration, the DEA noted the potential dangers of controlled substances and the the physician had "failed to exercise such care, and as a result, has ignored his duties as a health care professional to protect the public health and safety from the illicit use of these drugs" (55 Fed. Reg. 5307).

¹⁰Physician's registration revoked because he prescribed Ritalin and other drugs to drug addicts without a legitimate medical purpose. One patient was prescribed anabolic steroids after revealing he had taken them in the past, suffered from depression, and had attempted suicide ten months earlier. Medical expert testified that it is "medically dangerous" to give anabolic steroids to a patient with prior depression. DEA determined that his registration should be revoked, nothing that his actions threatened public health and safety.

¹¹Section 102 of the Pain Relief Act provides for education and training on the use of controlled substances for pain and the "means by which investigation and enforcement actions by law enforcement personnel may accommodate such use." Such education and training does not result in an expansion of DEA authority. As described above, DEA officials have been reviewing the actions of physicians for years using the "public interest" standard and providing continuing education to law enforcement personnel has been critical function of the CSA. Training DEA personnel, to ensure that actions they are already authorized to undertake show appropriate deference to legitimate medical practice, offers no evidence of increased authority under the CSA.

¹²Statement by President William Jefferson Clinton Upon Signing H.R. 1003, 33 Weekly Comp. Pres. Doc. 617 (May 5, 1997).

¹³See letter from Attorney General Janet Reno, dated June 5, 1998, to the Honorable Henry J. Hyde ("Reno Letter" or "DOJ Opinion").

Second, this statement makes clear that the DEA may take action against physicians assisting in a suicide in a state without a law permitting physician-assisted suicide.

Both of these statements are in the context of *existing law* and illustrate existing authority for the DEA to review physicians' activities under the CSA.

In Applying the Federal Controlled Substances Act, the Pain Relief Act Is Designed To Disregard Oregon's Death With Dignity Act or Similar State Statutes

The Pain Relief Act in the 106th Congress provides that, in applying the Controlled Substances Act, the Attorney General should not take into consideration any state law permitting assisted suicide. In effect, the legislation prevents action taken in accordance with Oregon's Death with Dignity Act or other similar state law to serve as a defense to action pursuant to the CSA. The legislation provides:

Notwithstanding any other provision of this Act, in determining whether a registration is consistent with the public interest under this Act, the Attorney General shall give no force and effect to State law authorizing or permitting assisted suicide or euthanasia.

S. 1272, § 101.

The Pain Relief Act is designed to disregard the Oregon Act in applying the Controlled Substances Act. This is one of the clear and stated purposes of the Act.

By disregarding the Oregon Act, the Pain Relief Act ensures that the Controlled Substances Act will be applied in the same manner to those dispensing controlled substances in Oregon as those in all other states.

Congress Has Authority To Regulate Controlled Substances and Preempt Conflicting State Laws

Congress has been regulating controlled substances since 1970 and has amended the CSA numerous times. Under the constitutional authority of the Commerce clause, Art. I, sec. 8, cl. 3, the Federal government has the power to regulate controlled substances and courts have consistently upheld the constitutionality of the CSA (*See, e.g., United States v. Wacker*, 72 F. 3d 1453, 1475 (10th Cir. 1996)).

Pursuant to the Supremacy clause of the Constitution, laws made under such authority are legally superior to any conflicting provision of a State law (U.S. Const. Art. IV). As the Supreme Court noted in *Ray v. Atlantic Richfield*, "even if Congress has not completely foreclosed state legislation in a particular area, a state statute is void to the extent that it actually conflicts with a valid federal statute" (435 U.S. 151, 157 (1978)). Clearly, compliance with the Pain Relief Act would make compliance with the Oregon Act impossible. Where such a conflict exists, the Federal law is supreme. (*Id.*) Therefore, the provision in the Pain Relief Act to override reliance on the Oregon Act as a defense to any action under the CSA is constitutionally valid.

DON LEWIS.

AMERICAN MEDICAL ASSOCIATION,
Chicago, IL, April 6, 2000.

Hon. ORRIN HATCH,
Chairman, Committee on the Judiciary,
U.S. Senate, Washington, DC.

DEAR MR. CHAIRMAN: The American Medical Association (AMA) is writing to convey our support for your Amendment in the Nature of a Substitute offered to H.R. 2260, the "Pain Relief Promotion Act." We believe that your Substitute to the bill represents significant improvements in addressing the continuing concerns of the physician community regarding the proper roles of the state and federal governments in regulating the practice of medicine.

The AMA, as you know, is squarely opposed to physician-assisted suicide and believes it is antithetical to the role of physician as healer. We strongly advocated against the Oregon public initiative that has legalized physician-assisted suicide in the State. In crafting an appropriate legislative response, physicians have been deeply concerned that legislation must recognize that aggressive treatment of pain carries with it the potential for increased risk of death, the so-called "double effect." The threat of criminal investigation and prosecution for fully legitimate medical decisions is unacceptable to the AMA.

Thus, we are very pleased to note that your bill would recognize the "double effect" as a potential consequence of the legitimate and necessary use of controlled substances in pain management, and explicitly include this as a "safe harbor" provision for physicians in the Controlled Substances Act. This is a vital element in cre-

ating a legal environment in which physicians may administer appropriate pain care for patients and we appreciate its inclusion.

Following passage of the original version of H.R. 2260 in the House of Representatives, which the AMA supported, our physician membership, represented by the AMA House of Delegates, expressed a number of concerns about the bill. The AMA was directed by our House of Delegates to work to specifically modify the bill in a way so as to preserve the traditional role of the state in regulating legitimate medical practice and preclude the federal government from establishing protocols for pain management and palliative care.

We believe that the language of your Substitute includes essential clarifications of the original bill, specifically expressing the sponsors' intention to honor the existing authority of the states to regulate legitimate medical practice, while exercising the concurrent federal authority to regulate the prescribing and administration of controlled substances. The language of the Substitute has been carefully crafted to reflect this proper balance, and we believe that it fully satisfies the concerns expressed by our House of Delegates. We appreciate the efforts of the sponsors and the Committee staff in working with the AMA and interested state and national medical specialty societies to address physicians' concerns in this regard.

We also greatly appreciate the time and care demonstrated in crafting a bill that makes a strong statement against assisted suicide, while minimizing the potential for inappropriate federal intrusion into patient care decisions.

Respectfully,

E. RATCLIFFE ANDERSON, JR., MD.

PAIN CARE COALITION,
Washington, DC, April 5, 2000.

DEAR SENATOR: The Pain Care Coalition urges your support for the Chairman's substitute to H.R. 2260 we understand will be offered in the Judiciary Committee markup tomorrow.

The Pain Care Coalition is a national coalition that advocates for responsible pain care policies at the federal level. The Coalition was formed in 1998 by concerned organizations representing the interests of pain care professionals and their patients. Constituent members of the Coalition represent a broad spectrum of physicians and other health care professionals involved in the diagnosis and treatment of patients suffering from acute and chronic pain. Members also include those professionals who conduct biomedical and related research into the causes of pain and the effectiveness of diagnostic and therapeutic approaches to freeing patients from pain or lessening the pain of those who must live with it.

Questions concerning the Coalition may be directed to its Washington Representatives, Bob Saner and Amy Bacon, at 202-466-6550.

Sincerely yours,

JOEL R. SAPER, MD, FACP, *Chairman.*

[From the Oregonian, Oct. 19, 1999]

A STATE'S RIGHTS, A STATE'S WRONGS

NOT EVEN OREGON HAS A RIGHT TO INTRUDE ON FEDERAL GOVERNMENT'S TRADITIONAL REGULATORY ARENA

Nobody can say Oregon didn't have a full debate on assisted suicide before reaffirming in November 1997 what voters first passed a year earlier. Both sides expended much blood and treasure in the fight and it's natural to think the matter should end there. Oregon voters passed assisted suicide; Oregon should have assisted suicide.

Normally, we'd agree.

But Oregon's "Death with Dignity Act" barges into an area of long-standing federal jurisdiction—the Controlled Substances Act—and Measure 16 proponents' new infatuation with "states' rights" betrays a misunderstanding of the concept.

We mention this as Congress prepares to debate the Pain Relief Promotion Act of 1999. The bill would authorize federal health-care agencies to promote an improved palliative care, and not even our new states' rights enthusiasts are grouching about that proposed federal initiative. The Pain Relief Promotion Act also makes clear that alleviating pain and discomfort is an authorized and legitimate medical purpose for the use of controlled substances under the Controlled Substances Act.

Nobody minds this either, which is understandable, since it would ensure that federal drug laws don't get in the way of proper palliative care.

But the fur starts flying when the bill states that nothing in the Controlled Substances Act authorizes the use of these drugs for assisted suicide or euthanasia and that state laws allowing assisted suicide or euthanasia are irrelevant in determining if a physician has violated this federal law. Although the act wouldn't technically nullify Oregon's suicide law, doctors here would have to help patients die within the aid of federally controlled substances.

Initially, U.S. Drug Enforcement Administration Administrator Thomas Constantine ruled that using controlled drugs such as barbiturates to terminate patients violated the Controlled Substances Act, because assisted suicide was not a "legitimate medical practice." We couldn't agree more that helping patients kill themselves is not a "legitimate medical practice." But in a later decision, Constantine's boss, Attorney General Janet Reno, took a different view.

She stated there was no evidence that Congress, in the Controlled Substance Act, wanted to override the states' right to determine what was a "legitimate medical practice." Nor is there evidence, Reno continued, that Congress intended to hand the DEA power to decide the assisted suicide question.

A fair historical point. Congress probably couldn't imagine in 1969 that a state would countenance assisted-suicide using controlled substances—but what about now? Reno said the DEA shouldn't decide if physician-assisted suicide is a "legitimate medical practice," and that's a fair point, too. These issues, Reno stated, are fundamental questions of morality and public policy." But does Congress have a right to answer such questions in the context of the Controlled Substances Act?

Absolutely.

These are drugs the federal government already controls. The federal government wouldn't allow a state's doctors to dispense heroin simply because a state legalized it. The federal government didn't allow doctors to dispense marijuana even to terminally-ill patients—just because a few states' voters deemed this a nifty idea. Congress didn't even have to weigh in on medical marijuana; the administration made that decision on its own, because of its worries about drug addiction.

Clearly, Congress has every right to update or clarify U.S. law on the use of federally controlled substances for assisted suicide. If Congress can concern itself with drug addiction, surely it can—and should—concern itself with the quality of health care across the country.

It can—and should—concern itself with the effects of assisted suicide on that health care.

And it can—and should—approve the Pain Relief Promotion Act of 1999.

Don't Kill the Pain-Relief Bill

By WESLEY J. SMITH

Last week, by a vote of 271-156, the House approved the Pain Relief Promotion Act, designed to promote effective medical treatment of pain while deterring the misuse of narcotics and other controlled substances for assisted suicide. The bill's passage prompted an outpouring of hyperbole and misinformation from opponents. Here are the facts about the act:

• *It would not outlaw assisted suicide.* Critics accuse Congress of "overturning" Oregon's assisted-suicide referendum. Would that it did. In fact, the act would outlaw only the intentional use of con-

trolled substances to cause death. Lethal substances not controlled by federal drug regulations could still be prescribed legally in Oregon for use in assisted suicide.

• *It would not interfere with states' rights.* Under the Controlled Substances Act the federal government, not the states, has the authority to determine what is and is not a proper medical use of the drugs specified in the act. Thus, as an editorial in the (Portland) Oregonian noted, it is the Oregon law that "burges into an area of long-standing federal jurisdiction." Thus passage of the act would return national uniformity to the enforcement of federal drug laws.

• *It merely reaffirms existing federal law.* Because the act declares that assisted suicide is not a "legitimate medical purpose" under the Controlled Substances Act, critics have wrongly accused supporters of granting new authority to the Drug Enforcement Agency to punish doctors. In fact, DEA has had that authority for nearly 30 years. Since 1980 it has brought more than 250 enforcement actions for violating the federal legal standard of "legitimate medical purpose."

• *The medical community overwhelmingly favors it.* Proponents of the bill include the American Medical Association, the National Hospice Organization, the Hospice Association of America, the American Academy of Pain Management, the

American Society of Anesthesiologists and the American College of Osteopathic Family Physicians. (True, support isn't unanimous. Dissent within the medical community has been led by the Rhode Island Medical Association.)

• *It has broad bipartisan support.* Seventy-one House Democrats voted for the bill, and its Senate sponsors include Joe Lieberman (D., Conn.), Chris Dodd (D., Conn.) and Evan Bayh (D., Ind.).

• *It would enhance pain control.* If the act becomes law, pain control will for the first time be specifically identified in federal law as a proper use of controlled substances—even if the use of pain-controlling drugs has the unintended side effect of causing death. That is a much-needed legal reform, because many doctors fail to treat pain aggressively because they fear the government's second-guessing. Several states have recently passed similar laws, leading to dramatic increases in the use of morphine and other palliative medications.

The Pain Relief Promotion Act looks likely to pass the Senate. If President Clinton truly feels our pain, he will sign it the moment it hits his desk.

Mr. Smith is a lawyer for the International Anti-Euthanasia Task Force. His book "Culture of Death: The Destruction of Medical Ethics in America" will be published next year by Encounter Books.

The CHAIRMAN. Senator Wyden.

STATEMENT OF HON. RON WYDEN, A U.S. SENATOR FROM THE STATE OF OREGON

Senator WYDEN. Thank you, Mr. Chairman. Mr. Chairman, the obligatory part of any Senate hearing is that someone on my side of the dais says nice things about the person on your side of the dais who chairs the hearing.

The CHAIRMAN. You do not have to, Senator. [Laughter.]

I will alleviate that.

Senator WYDEN. I want to talk about our 20 years together, because if you scroll down the computer, you see our work, for example, on the community health center legislation. The New York Times said that was, in the 102d Congress, the most important bill for low-income people. We made it possible for hundreds of thousands of low-income citizens, you and I, with your leadership, to get good health care without costing the taxpayer a penny.

So one of the reasons that I come today with so much regret is that I have asked your counsel on health care issues since I was a young member of the House on the Waxman committee specializing in health, and because I so value your counsel and input is why I have so much regret that I come today to say that I am especially concerned that the substitute is going to undermine so much of the work that you have championed that provides effective and human health care for the millions that suffer in this country.

I have said it before but I would like to repeat it. I strongly oppose physician-assisted suicide. I voted against the Oregon ballot measure twice. As the former Director of the Oregon Gray Panthers, I witnessed firsthand how the poor and the vulnerable so often receive inadequate health care. I have long been worried about the adequacy of the Oregon ballot's measure to protect those who are poor, especially the poor elderly.

In addition, my religion, my views as a Jew have taught me about the infinite value of human life. Rabbi Bleich is going to testify soon. He is certainly more learned than I on these matters, but rabbis from the Orthodox to the Reform continually stress that life's value is infinite, while at the same time they emphasize that every responsible measure ought to be taken to comfort the ill.

For a variety of these personal, moral, and religious reasons, I did vote against the Oregon ballot measure, and as a Senator, I voted against using Federal funds for assisted suicide.

If there were a significant constitutional issue at stake or another compelling national interest, or had the people in my State acted in haste and without adequate examination and debate, I would not be such a strong defender of the Oregon law. Those issues are not present here. The Supreme Court has made it clear that States have the right to either ban or authorize assisted suicide without impinging on any constitutional protections.

Further, no one has said that my State acted precipitously. We had two lengthy and exhaustive debates that dominated the water coolers and dinner tables of the people of my State for two years.

Mr. Chairman, I recognize that others sincerely view this issue differently, but I firmly believe that my election certificate does not give me the authority to substitute my personal and religious be-

liefs for the judgment made twice by the people of Oregon. The States have always possessed the clear authority to determine acceptable medical practice and acceptable medical uses of controlled substances and I am going to fight with all my strength to preserve Oregon's rights on this matter.

Today, however, the committee need not confront the issue of whether Oregon has the right to choose its own course on physician-assisted suicide. As you touched on in your opening statement, every member of the Senate agrees that there is a strong national interest in reducing the demand for physician-assisted suicide. If we can agree on that issue, the legislation that is offered today should be rejected, but a bipartisan bill that I wrote with the leadership of Senator Mack and Senator Smith should be passed to help the suffering.

Despite the well-intentioned efforts that you have, Mr. Chairman, and your sincerity, nothing really changes in my reading of the substitute. Your bill would authorize local, State, and Federal law enforcement officials without expertise and training in health care to dissect a physician's intent with respect to prescribing pain relief medicine. It would allow the Federal Government to intrude into the doctor-patient relationship at one of the most difficult and personal times of an individual's life. Despite the language that was included concerning the State's role, the effect would be the same. Physicians' fear of being investigated by law enforcement and losing their ability to practice medicine is going to result in less-aggressive pain relief for countless patients.

"The New England Journal of Medicine," in their editorial against these legislative approaches that would overturn Oregon's law, said, "Many doctors are concerned about the scrutiny they invite when they prescribe or administer controlled substances and they are hyper-sensitive to drug-seeking behavior in patients. Patients, as well as doctors, often have exaggerated fears of addiction and the side effects of narcotics." The New England Journal of Medicine, Mr. Chairman, said, and I quote, "Congress would make this bad situation worse."

Allow me for a moment to give this situation some proportion. I hope that the committee will consider that this bill will sentence millions of patients and communities across this country to needless suffering to stop several dozen terminally ill Oregonians whose personal and religious beliefs are different from yours and mine.

Now, some with the argument of straight States' rights use the Controlled Substance Act when attempting to explain their support of a new approach to federalism as it relates to the State of Oregon. They assert that the Federal role in overturning Oregon's law is self-evident because controlled substances are regulated under Federal law and enforced by a Federal agency. As someone who has spent decades now studying pharmaceutical and drug issues, I strongly believe that this analysis misses the point.

It is true that the Federal Government controls drugs through the Controlled Substance Act for the purposes of preventing and detecting illegal diversion, sale, and abuse. The Federal Government does have an appropriate role there in regulating the distribution of controlled substances. But when it comes to deter-

mining a legitimate medical purpose of these controlled substances, these drugs have always fallen under the supervision of the States.

States regulate the use of controlled substances through the individual medical practice acts, pharmacy practice acts, medical board regulations, and pharmacy board regulations. Many States even have their own intractable pain acts regulating the use of controlled substances. These States approach the issue differently, but the bottom line is that they have focused on the medical practice issue without disturbing the Federal Government's jurisdiction over the unauthorized, abusive diversion or sale of drugs.

If we are to decrease the demand for physician-assisted suicide, we have got to address the reasons why people seek this option. I am frankly astounded at the horrendous job that is now done to relieve the needless suffering of sick and dying patients. The under-treatment of pain, Mr. Chairman, is a well-documented public health crisis in this country and I believe, tragically, one of the unintended consequences of this bill is that this substitute is going to compound the under-treatment of pain across this nation.

As you know because of our conversations, I very, very much want to work in a bipartisan way on this issue. My whole approach for 20 years, Mr. Chairman, has been to work in a bipartisan way, whether it is health care, whether it is technology, whether it is trade. That has been the calling card of my approach for more than 20 years. That is why I think that the legislation that Senator Mack, Senator Smith and I developed makes sense, because it will allow us to improve pain relief in every nook and cranny of this country without causing problems that are going to cause physicians in every part of this nation to have second thoughts before they reach for their prescription pad, which is what I think the practical effect of the substitute will be.

Mr. Chairman, I have challenged the Oregon health community to develop a model for hospice care so we can provide better care for the dying. The evidence clearly shows that when people have access to good hospice care, they are less likely to seek physician-assisted suicide. That is what the bipartisan bill with Senators Mack and Smith does. In addition to that legislation, I have worked with Senators Grassley and Breaux to review, and the GAO is doing so now, barriers to hospice care around the nation. The vast majority of Americans do not even know what hospice care is, nor do they get the full six-month benefit available to them through the Medicare program.

We should recognize that if the Pain Relief Promotion Act were to pass, demand for physician-assisted suicide would still exist because the bill fails to address the reasons that currently drive people to seek this option.

Finally, Mr. Chairman, I point out that regardless of where a person stands on the issue, the evidence suggests that Oregon is doing a far better job of providing safeguards to the terminally ill than is the rest of the country. The Oregon law requires examinations by physicians and mental health professionals to ensure that an individual who seeks assisted suicide is not only terminally ill and facing imminent death but of competent mind. What has gone unreported in this debate are thousands of physician-assisted suicides that have gone on in this country for many years without the

safeguards that we see in the Oregon statute, and I would refer to several studies, Mr. Chairman, in my prepared remarks that highlight that particular point.

Again, I thank you for holding this hearing. I hope that we can set aside, Mr. Chairman, the substitute, work together as I have sought to do with Senators Mack and Smith. And by the way, for the record, when I began this effort, I went to Senator Nickles. I went to Senator Nickles and asked him to work together with me to try to find a common ground.

But, obviously, today we have differences of opinion, but the stakes are too important and too high to move precipitously under political duress. I would like to wrap up by asking for inclusion in the record of a statement in opposition to the substitute by the American Academy of Family Physicians. They represent over 89,000 family physicians and residents nationwide. They oppose the substitute. I would ask that their statement and a legal analysis by the Oregon Medical Association, a letter of opposition by more than 40 leading bioethicists, a statement by the American Pharmaceutical Association that evaluates the legislation, and a statement by the Oregon Hospice Association be made a part of the record, as well.

I thank you, Mr. Chairman.

The CHAIRMAN. Without objection, we will put that in the record. [The information of Senator Wyden follows:]

PREPARED STATEMENT OF THE AMERICAN ACADEMY OF FAMILY PHYSICIANS

This statement is submitted to the Senate Judiciary Committee in opposition to H.R. 2260, the Pain Management Promotion Act, by the American Academy of Family Physicians. The Academy represents 89,4000 practicing family physicians, family practice and medical students.

H.R. 2260 passed the House of Representatives on October 27, 1999 by a vote of 271-156. The intent of H.R. 2260, *The Pain Relief Promotion Act of 1999*, is to prevent federally controlled substances from being used in an assisted suicide. H.R. 2260 clarifies that the use of federally controlled narcotics to control pain is acceptable, and recognizes that the legitimate use of narcotics may increase the risk of death. The bill also clarifies that the use of controlled substances to assist in a suicide is illegal. The Academy opposed passage of H.R. 2260 by the House and remains opposed to passage in the Senate.

The Academy opposes physician assisted suicide as being fundamentally inconsistent with the physician's role as a healer. The Academy opposes H.R. 2260, not because it attempts to outlaw physician assisted suicide, but because in its attempt to do so, it may put at risk for criminal investigation physicians who are aggressively and appropriately prescribing narcotics to patients who are in great pain. Specifically, the measure calls for the Drug Enforcement Administration (DEA) to train its agents on how to determine whether the death of a patient was a result of physician assisted suicide, utilizing various sets of guidelines. Assessments by non-medical personnel of physicians' clinical management of patients is likely to result in the questioning of appropriate treatment regimens provided by well trained physicians acting in the best interest of their patients who are suffering severe pain. Such scrutiny of physicians, performed within the construct of DEA authority by DEA agents, may well create a chilling environment for the physician whose goal is appropriate medical treatment of a patient's pain.

Chairman Hatch (R-UT) has drafted a substitute measure in an attempt to address the concerns of the medical community. Although Chairman Hatch's substitute is an improvement over the House-passed version of H.R. 2260, the Chairman's mark retains objectionable provisions.

In particular, Sec. 102 of H.R. 2260 and Sec. 202 of the Chairman Hatch's mark would allow training of federal, state, and local law enforcement personnel on how to conduct investigations and enforcement actions involving controlled substances prescribed for pain management at the end of life. Such training would incorporate the recommendations of the Secretary of Health and Human Services. Training law

enforcement officers who have no clinical education in medical decision making to review complicated end-of-life care decisions invites misunderstanding and misidentification of violations. Such training is also a way to redirect officers from their emphasis on drug traffickers to second-guessing physician decisions on pain management. For these reasons, the Academy opposes the Chairman's mark.

We would note, however, that the Chairman's mark does contain language that makes it preferable in some areas to the House-passed version of H.R. 2260. Specifically, the following sections are improvements over the House-passed bill:

Section 2. Findings (5) (page 2): This section finds that "adequate treatment of pain, especially for chronic diseases and conditions, irreversible diseases such as cancer, and end-of-life care, is a serious public health program affecting hundreds of thousands of patients every year; physicians should not hesitate to dispense or distribute controlled substances when medically indicated for these conditions." This language could be improved further by including the phrase, "in the quantities necessary."

Title I Section 903(a) (page 3): This section emphasizes that the Agency for Healthcare Research and Quality may not develop national pain management standards, a change requested by this organization.

Title II(a) (page 9): This section makes clear that states retain the sole discretion with respect to the licensure of physicians and state prescribing privileges. There has been concern that this act creates a kind of national de facto licensure, to the extent that prescribing controlled substances is essential to practice.

Title II(a)(4)(B) (page 9) Prohibits the Attorney General from issuing national standards for pain management.

Title II(b)(2) (page 10) Represents perhaps the most important improvement in the draft. It increases the burden of proof greatly in any Department of Justice or Drug Enforcement Administration administrative, or civil, action against physicians accused of causing, or assisting in causing the death of a patient. The Attorney General has the burden, under this section of "proving, by clear and convincing evidence, that the practitioner's intent . . . was causing death or assisting another person in causing death."

Despite the above noted improvements, however, the substitute proposal retains the objectionable elements of H.R. 2260, which are the basis for the Academy's opposition to passage of the legislation.

Legislation such as H.R. 2260, or modifications to it like the Chairman's mark, may result in further government interference into clinical decision making, and may potentially subject physicians treating patients appropriately to scrutiny by DEA agents utilizing a set of government guidelines to assess medical practice. The American Academy of Family Physicians cannot support legislation that may create an environment in which physicians are fearful of treating their patients appropriately. Therefore, the Academy urges that the Judiciary Committee not support H.R. 2260 or the Chairman's mark.

OREGON MEDICAL ASSOCIATION,
Portland, OR, April 21, 2000.

Hon. ORRIN HATCH,
Washington, DC.

DEAR SENATOR HATCH: The Oregon Medical Association has been informed that the Senate Judiciary Committee will hold a hearing on the Pain Relief Promotion Act on April 25th, 2000. I respectfully request that the Oregon Medical Association Counsel's analysis of the Act be included in the record of the Judiciary Committee's hearing.

Sincerely,

RICHARD KINCADE, MD, *President.*

LAW OFFICES OF COONEY & CREW, P.C.,
Portland, OR, April 10, 2000.

Re: proposed substitute text to Pain Relief Promotion Act of 1999.

SCOTT GALLANT,
Director of Government Affairs,
Oregon Medical Association, Portland, OR.

DEAR SCOTT: I have reviewed Senator Hatch's proposed substitute text ("Hatch's Substitute") for the Pain Relief Promotion Act of 1999 ("PRPA") which amends Section 303 of the Controlled Substances Act, 21 USC §823 ("CSA"), and provided

below a brief analysis of the changes. As you probably know, some of the changes contained in the Hatch Substitute follow the proposed language of the American Medical Association's ("AMA's") Working Draft Amendments to U.S. Senate Bill 1272, PRPA, which we reviewed earlier and are of the significant concern. On the other hand, a number of changes, including those to Title I, Sections 101 through 104 of the PRPA, are not substantive beyond adding the terms "pain and" to the Act's references to palliative care and expanding the definition of such care.

In my previous analysis of the AMA's Working Draft Amendments to S. 1272 (AMA HOD; 1-99), I discussed the fact that the proposed AMA language would not eliminate federal intrusion into standard of care issues. In addition, we have expressed our concerns on previous occasions about the PRPA leaving the door open for the federal government to second guess physicians' prescribing practices. By attempting to define, regulate and enforce the meaning of a "legitimate medical purpose," the PRPA expands the Drug Enforcement Agency's ("DEA's") authority to question a physician's decision in prescribing controlled substances. Under the PRPA, the DEA can initiate intrusive and time-consuming investigations into physicians decisions regarding pain and palliative care, whether the physician acts are consistent with state laws (regarding pain or other standards) and regardless of whether the physician's patient dies. We believe the increased federal scrutiny would have a chilling effect on physicians' willingness to engage in necessary, sometimes aggressive, sometimes innovative approaches to pain care.

The Hatch Substitute, like the AMA's Working Draft Amendments, does nothing to alleviate our concerns over heightened federal scrutiny and intrusion into the practice of medicine. Although the language appears to leave intact the State's independent authority to decide questions on scope and standards of medical care, the Hatch Substitute effectively strengthens the federal governments authority in such instances.

The Hatch Substitute adds the following language to Title II, Section 201 of the PRPA:

"(i)(3) Nothing in this subsection shall be construed to alter the roles of the Federal and State governments in regulating the practice of medicine. Regardless of the whether the Attorney General determines pursuant to this section that the registration of a practitioner is inconsistent with the public interest, it remains solely within the discretion of State authorities to determine whether action should be taken with respect to State professional license of the practitioner or the privileges of the practitioner to prescribe controlled substances in the State."

The above language apparently attempts to maintain the current roles of federal and state authorities with respect to the practice of medicine. This provision leaves intact, however, only states' discretion with respect to a practitioner's state license or state prescribing privileges. The added language, when viewed in the context of reality, is meaningless. In Oregon, as in all other states, the right to prescribe controlled substances is predicated on the physician holding a "current DEA registration." If the federal government should find the practitioner in violation of the PRPA, it is quite likely that the DEA would revoke the physician's registration which in turn would eliminate the doctor's right under state law to issue script for federally controlled substances. It is our experience that the effect on a physician's practice of losing prescribing privileges is career-ending.

The Hatch Substitute further provides

"(i)(4) Nothing in the Pain Relief Promotion Act of 2000 (including the amendment made by such Act) shall be construed—
 "(A) to modify the Federal requirements that a controlled substance be dispensed only for a legitimate medical purpose by a practitioner acting in the usual course of professional practice,"

In contrast to Section (3) above which allows states to independently enforce their own licensing and prescribing rules and regulations, Section (4)(A) reiterates the federal government's authority to investigate and decide questions of what is or is not a legitimate medical purpose and what is the usual course of medical practice in the context of federal legislation for prescribing controlled substances. As such, a physician may not be disciplined under State rules for a particular course of treatment, but may be subject to criminal penalties and loss of registration under the federal rules for the exact same conduct.

Section (4)(B) of the Hatch Substitute also appears to limit federal authority by stating that nothing in the PRPA shall be construed:

"(B) to provide the Attorney General with the authority to issue national standards for pain management and palliative care clinical practice, research, or quality".

The Attorney General may not codify or promulgate "national standards" or protocols regarding pain and palliative care under the proposed regulation, but may nonetheless impose her own set of standards (through enforcement personnel with little or no expertise in the provision of pain or palliative care) in deciding, on a case-by-case basis, the fate of individual physicians prescribing controlled substances for pain care.

Moreover, the language at the end of Section (4) "except that the Attorney General may take such other action as may be necessary to enforce the Act" leaves little doubt that a state's ability to determine and enforce its own guidelines and standards for pain care is subject to federal authority. This broad language, which makes the PRPA internally inconsistent with the above language, essentially vitiates any of the PRPA's language that appears to empower or maintain a state's authority to regulate the practice of medicine within its own borders.

Identical to the AMA's proposed Amendment #3 to the PRPA (which amends Section 304(c) of the Controlled Substances Act), the Hatch Substitute also proposes to add the following language to the PRPA:

"(2) BURDEN OF PROOF.—At any proceeding under paragraph (1) where the order to show cause is based upon the alleged intentions of the applicant or registrant to cause or assist in causing death, the Attorney General shall have the burden of proving, by clear and convincing evidence, that the practitioner's intent was to dispense or distribute a controlled substance with a purpose of causing or assisting in causing, the suicide or euthanasia of any individual. In meeting such a burden, it shall not be sufficient to prove that the applicant or registrant knew that the use of the controlled substance may increase the risk of death."

We remain concerned that this language put a physician's state of mind at the center of any DEA investigation regarding that physician's treatment for pain care. If someone believes a physician acted for the wrong purpose, the physician will have to defend his or her state of mind at the time of treatment, and because indirect and circumstantial evidence of one's state of mind is not always reliable, a physician with no intent to assist in a patient's death could be found to have violated the PRPA if the trier of fact believed the testimony of witnesses who testified as to what they believed or perceived the physician's state of mind [intent] to be.

Under the proposed Bill, the line between acceptable palliative or pain care and unacceptable assisted suicide rests solely on the physician's intent. When intent is the critical issue, physicians must, and will, worry that law enforcement officials will see a criminal intent even where none existed. Physicians, under the PRPA, put not only their registration at risk, but also face possible criminal prosecution if determined to have possessed the wrong kind of intent. Physicians will likely err on the side of more caution in treating pain, with the possible result that tens of thousands of patients will die without adequate pain or palliative care, possibly subjecting physicians to civil liability for defensive treatment decisions.

In summary, the Hatch Substitute's apparent attempt to maintain state authority vis-a-vis the federal government is illusory. The federal government retains the ability to define, regulate, and enforce on a case-by-case basis, questions of whether a physician's actions and intent meet federal requirements that a controlled substance be dispensed only for a legitimate medical purpose by a practitioner acting in the usual course of professional practice.

Sincerely,

STEVEN T. CONKLIN.

LAW OFFICES OF COONEY & CREW, P.C.,
Portland, OR, July 9, 1999.

Re Federal Pain Relief Promotion Act of 1999.

Mr. SCOTT GALLANT,
Director of Governmental Affairs,
Oregon Medical Association, Portland, OR.

DEAR SCOTT: The purpose of this correspondence is to follow up on our initial June 23, 1999 analysis of the Federal Pain Relief Promotion Act of 1999 (S. 1272) which was introduced by Senator Don Nickles (R-Okla.) on June 23, 1999. A similar version was introduced in the House of Representatives by Representative Henry Hyde (R-Ill.) (H.R. 2260). The main purpose of these bills is to define when dispensing pain medication is a legitimate medical purpose and to prohibit dispensing of controlled substances for the purpose of causing the death of an individual. Contrary to earlier opposition of similar proposed legislation, the American Medical Association (AMA) apparently supports passage of this particular bill. Consequently,

you wanted to know whether the current legislation proposal radically differs from earlier bills addressing this issue (which would explain the AMA's change in position), or is the AMA now simply contradicting earlier statements which questioned the authority of the federal government to regulate directly the practice of medicine.

QUESTION PRESENTED

Does the Pain Relief Promotion Act of 1999 raise similar legal issues regarding the authority of the federal government to regulate the practice of medicines as did the Lethal Drug Abuse Prevention Act of 1998?

SHORT ANSWER

Compared to earlier proposed legislation, the current legislation proposal to amend the Controlled Substances Act raises similar legal issues regarding the authority of the federal government to regulate the practice of medicine.

Discussion

In July 1998, members of Congress debated the Lethal Drug Abuse Prevention Act which would have prohibited the dispensing of a controlled substance with a purpose of causing the suicide of an individual.¹ At the time, the AMA testified in opposition to the bill before a House subcommittee. The main concerns voiced by the AMA were that the bill might discourage appropriate aggressive palliative care and that the legislation represented an unacceptable federal intrusion of the DEA into state regulation of the practice of medicine.²

Now in 1999, Congress is revisiting this issue with the Pain Relief Promotion Act. While not identical to earlier legislative proposals, the bill effectively has the same effects. The Controlled Substances Act would be amended to state that alleviating pain or discomfort is a legitimate medical propose for dispensing, distributing, or administering controlled substances, but the bill would not authorize intentionally dispensing, distributing or administering controlled substances for the purpose of causing death.³ Simply put, the bill would prohibit the current legal practice of prescribing controlled substances pursuant to Oregon's Death With Dignity Act.

¹HR 4006, 105th Congress, 2d Session (Jun. 5, 1998). Specifically, the bill would have amended the Controlled Substances Act to state that a physician's Drug Enforcement Administration (DEA) license could be revoked upon a finding that the physician:

has intentionally dispensed or distributed a controlled substance with a *purpose of causing or assisting in causing, the suicide or euthanasia of any individual, except that this paragraph does not apply to the dispensing or distribution of a controlled substances for the purpose of alleviating pain or discomfort* (even if the use of the controlled substances may increase the risk of death), so long as the controlled substance is not also dispensed or distributed for the purpose of causing, or assisting in causing, the death of an individual for any reason. (Emphasis added.)

²Hearing on HR 4006, before the Subcommittee on the Constitution of the House Committee on the Judiciary (Jul. 14, 1998) (presented by Thomas R. Reardon, MD). With respect to palliative care, the AMA stated that:

[U]nder the terms of H.R. 4006, aggressive drug therapies for pain management will become automatically suspect. Physicians are only human and will go to great lengths to avoid a Department of Justice investigation . . . as anyone would. A Department of Justice investigation, which under the terms of this bill could be instigated by any individual, could result in physician's (1) loss of federal DEA license for prescribing controlled substances; (2) exclusion from participation in the Medicare and Medicaid programs; and (3) possible criminal prosecution. The is no question but that H.R. 4006 would effect physician decision-making and have the perverse effect of chilling appropriate palliative care.

Regarding the proper roles of state and federal government, the AMA concurred with the Attorney General's June 5, 1998 opinion which provided that neither the language of the Controlled Substances Act or its legislative history supported the Act's application to physicians who are in compliance with state law. The AMA stated that:

Any other reading makes the DEA an arbiter of the practice of medicine. This is unacceptable conclusion. It is the state legislatures, through the police powers, that determine the scope of medical practice. State medical boards are universally authorized by their state statutes to investigate reports of improper prescribing as possible evidence supporting suspension or revocation of a physician's license to practice medicine. This is the proper purview of the state.

³S. 1272, 106th Congress, 1st Session (Jun. 23, 1999). Instead of amending the provision which sets forth grounds for disciplinary action (as with former H.R. 4006), this bill would amend the registration requirements for a DEA license to state:

For purposes of this Act *and any regulations* to implement this Act, alleviating pain of discomfort in the usual course of professional practice is a legitimate medical purpose for the dispensing, distributing, or administering of a controlled substance that is consistent with public health and safety, even if the use of such a substance may increase

Upon introduction, Senator Nickles indicated that the House of Delegates of the AMA voted to support the bill.⁴ Because the current legislative proposal to amend the Controlled Substances Act raises similar legal issues as those found in an earlier bill directly opposed by the AMA, the AMA appears to have departed from its views which sought to protect appropriate palliative care and support the role of the states in determining the scope of the practice of medicine. Both the threat against appropriate palliative care and the traditional role of the states remain in the current bill.

With respect to palliative care, the authority of the DEA to regulate the legitimate use of controlled substances would be expanded under the 1999 Act. Specifically, the Act provides that alleviating pain in the usual course of professional practice is a "legitimate medical purpose," and authorizes agency rulemaking to implement this new federal definition. Furthermore, the Act creates programs to train law enforcement personnel (both federal and nonfederal personnel) on the "legitimate use of controlled substances in pain management." A logical consequence of such federal expansion into determining standards of care for pain management would be closer scrutiny of clinical decisions to administer pain medication when those decisions may increase the risk of death in order to provide adequate comfort of the patient. As the AMA rightly pointed out in 1998, physicians may think twice about aggressive drug therapies for pain management due to fear of federal investigations. The AMA also pointed out that states are beginning to adopt guidelines for palliative care and this type of proposed legislation could undo such efforts.⁵ What would happen if a state's legislative standards regarding palliative care conflicted with rules adopted by the DEA? At the very least, a debate would be created about the preemption of the state standards by the federal standards.

With respect to state regulation of the practice of medicine under this 1999 Act, the federal Department of Justice (through the DEA) clearly would become involved in the creation and enforcement of rules governing when dispensing pain medication is a legitimate medical purpose.⁶ Furthermore, the Act specifically instructs the Attorney General to ignore state law.⁷ Granted the main consequence of the Act effectively would prohibit physician-assisted suicide in Oregon, but another consequence would be that the federal government may create pain management standards that directly conflict with existing state efforts to address palliative care. In theory, under the Act only the DEA would have the authority to decide when prescribing controlled substances is for a legitimate medical purpose. This is direct federal involvement in setting standards of medical care. From a constitutional perspective, direct control of the practice of medicine traditionally has been left up to the states under their police powers.⁸ Even the Controlled Substances Act requires the federal government to take into account state law.⁹ But here, not only does the proposed

the risk of death. Nothing in this section authorizes intentionally dispensing, distributing, or administering a controlled substances for the purpose of causing death or assisting another person in causing death. (Emphasis added.)

As a direct attempt to preempt Oregon's law, the bill states:

Notwithstanding any other provision of this Act, in determining whether a registration is consistent with the public interest under this Act, the Attorney General shall give no force and effect to State law authorizing or permitting assisted suicide or euthanasia.

Finally, the education provisions of the Controlled Substances Act would be expanded to include programs:

[f]or local, State and Federal personnel . . . on the necessary and legitimate use of controlled substance in pain management and palliative care, and means by which investigative and enforcement actions by law enforcement personnel may accommodate such use.

⁴Statement on Introduction of Pain Relief Promotion Act of 1999 (Sen. Nickles) (Jun. 23, 1999).

⁵See, e.g., ORS 677.474 (stating that a physician shall not be subject to disciplinary action by the Board of Medical Examiners for prescribing or administering controlled substances in the course of treatment of a person for intractable pain).

⁶S. 1272, Section 101.

⁷S. 1272, Section 101.

⁸*Linder v. United States*, 268 U.S. 5, 18 (1924).

⁹21 U.S.C. § 903 states:

No provision of this subchapter shall be construed as indicating an intent on the part of Congress to occupy the field in which that provision operates, including criminal penalties, to the exclusion of any State law on the same subject matter which would otherwise be within the authority of the State, unless there is a positive conflict between that provision of this subchapter and that State law so that the two cannot consistently stand together.

Continued

bill expand the DEA's authority to regulate the practice of medicine, the bill explicitly requires the federal government to ignore state law altogether. Again, in 1998 the AMA strongly urged Congress to reconsider the wisdom of making the DEA "an arbiter of the practice of medicine." This bill does just what the AMA cautioned against in 1998.

CONCLUSION

Putting aside the moral and ethical considerations with respect to Oregon's Death With Dignity Act and physician-assisted suicide in general, the recent federal proposal to legislate palliative care standards and give authority to federal, state, and local law enforcement officials to monitor and investigate the legitimate use of controlled substances in pain management clearly puts the federal government in the business of regulating the practice of medicine. Neither the current language of the Controlled Substances Act nor the U.S. Supreme Court support this role for the federal government.¹⁰

Please let us know if you have further questions or concerns regarding the Pain Relief Promotion Act of 1999.

Sincerely,

MARK A. BONANNO.

UNIVERSITY OF PITTSBURGH,
Pittsburgh, PA, April 24, 2000.

Re H.R. 2260, Pain Relief Promotion Act of 1999.

Senator ARLEN SPECTER,
Hart Senate Office Building,
Washington, DC.

DEAR SENATOR SPECTER: We, a group of bioethicists of differing views about the moral issues arising in end-of-life situations, are writing to you to express our common opposition to the Pain Relief Promotion Act, H.R. 2260, hereinafter "PRPA". Our opposition rests on several grounds, with particular emphasis on the ethical and moral aspects of this bill. As bioethicists, we find it crucial to protect and promote ethical behavior by physicians. Of course, we recognize that the PRPA may be intended, in the view of some, to do just that by prohibiting physicians from assisting in suicide—more specifically, from prescribing federally controlled drugs for hastening the deaths of terminally ill patients who request it, even where this has been made legal—but this bill can be expected to have just the opposite effect. It threatens to undermine the conditions for ethically acceptable physician behavior in a much wider range of areas. It is a dangerous bill, truly a wolf in the clothing of a sheep.

1. PRPA can be expected to put physicians in an impossible ethical position. The physician must either abandon the patient to pain and suffering, in the many situations in which these cannot be adequately relieved, or risk federal investigation and imprisonment. Because the conditions for determining intent on the part of the physician are open to vagaries of judgment, physicians will be forced to take the most cautious route, even when treating solely for pain. The prospect of 20 years in jail is not a risk many physicians will be willing to take, even to ease the pain of patients to whom they are deeply dedicated and for whom they have been caring over a long period of time. They will be even less willing to do so for patients who are poor, who are members of vulnerable groups, or are otherwise more distant from them.

2. The treatment of pain, whether at the end of life or at any other time, involves sensitive medical decisions that should be made by doctors and patients, not by legislators or regulators. The presence of federal inspectors will have a predictable—and intolerable—dampening effect on physicians' capacities for adequate pain control. This will sabotage not only the very considerable recent progress in pain and symptom control that has been made over the last several years, but will render H.R. 2260 inconsistent on its face: it announces itself as a "pain relief promotion" act, but will undercut the effective delivery of pain relief.

While this provision does not prevent Congress from enacting new legislation which would create a positive conflict with a state law, even the factors considered in DEA registration are supposed to take into account state law. For example, in registering physicians in order to permit them to distribute controlled substances, consideration shall be given to "compliance with applicable State and local law," 21 U.S.C. § 823(b)(2) and (e)(2). This bill completely ignores state law.

¹⁰21 U.S.C. § 903; 21 U.S.C. § 823; *Linder v. United States*, 268 U.S. 5 (1924).

The evidence for this claim is legion. Repeated studies document that when physicians have reason to believe that their prescribing practices will bring scrutiny, they are less likely to prescribe appropriate medications. This has been demonstrated when the scrutinizing parties are medical disciplinary boards, which have only the power to limit or terminate a physician's license;¹ the PRPA would have an even more detrimental effect on appropriate prescribing practices since the penalties are criminal and involve prison sentences. Attention to adequate pain control has been one of the most important gains in the end-of-life debates; this legislation would reverse these gains.

3. Doctors would be under the surveillance of the criminal justice system, a system which has no expertise in the sensitive sorts of decisions that must be made by a patient and his or her physician as the patient is dying. Both physicians and patients resent what they view as intrusions by government in this intimate professional relationship.

4. H.R. 2260 will not eliminate physician-assisted suicide. Every study that has been conducted in this country reveals its occurrence, in every part of the country where such research has been undertaken, underground and in completely uncontrolled conditions.² The bill will simply drive the practice further underground, into more disguised and more unprotected conditions.

5. The duplicity of the "Pain Relief Promotion Act" will—and should—arouse substantial public opposition. Among its purposes, acknowledges Senator Nickles in his written comments on the bill, is the objective of rendering inoperable laws legalizing physician aid-in-dying, such as that which was passed resoundingly by the citizens of Oregon; it provides comparatively token attention to pain relief as a cover for so doing.

The undersigned hold many different positions on Oregon's law and other "right-to-die" legislation. But we are united in our alarm at the dire consequences the passage of this legislation would have, both for physicians and for their patients whose pain can be relieved only with adequate prescribed controlled substances. There have been important recent gains in pain control for the dying; we ask you not to undercut them with this dangerous bill.

[We would appreciate your making this letter a part of the record of the April 25, 2000 hearing on this bill. The views expressed by the signatories to this letter are their own and not those of their institutions, which are listed for identification purposes only.]

Sincerely,

Alan Meisel, J.D., Director, Center for Bioethics and Health Law, and Dickie, McCamey & Chilote Professor, Bioethics and Professor of Law, University of Pittsburgh.

Howard Degenholtz, Ph.D., Assistant Professor, Health Services Administration, Center for Bioethics and Health Law, University of Pittsburgh.

Lawrence A. Frolik, Professor of Law, University of Pittsburgh School of Law.

David Barnard, Ph.D., Professor and Director of Palliative Care Education, Center for Bioethics and Health Law, University of Pittsburgh.

Lisa S. Parker, Ph.D., Associate Professor, Center for Bioethics and Health Law and Department of Human Genetics, University of Pittsburgh.

Bradley Lewis, Department of Psychiatry, Center for Medical Ethics, Program for Cultural Studies, University of Pittsburgh.

¹ "Breaking Down the Barriers to Effective Pain Management," Recommendations to improve the Assessment and Treatment of Pain in New York State, Report to the Commissioner of Health, January 1998 (70% of New York physicians acknowledge declining to prescribe controlled substances when indicated due to concern that prescribing would bring scrutiny); Institute of Medicine, *Approaching Death, Improving Care at the End of Life*, at p. 191, 197 (National Academy Press, 1997) (system of oversight for prescribing controlled substances is burdensome and deters legitimate prescribing of opioids to patients at the end of life); David Joranson, *State Medical Board Guidelines for Treatment of Intractable Pain*, *American Pain Society Bulletin*, vol. 5, no. 3 (May/June 1995), at 2 (citing California study reflecting that physicians avoid prescribing controlled substances for pain due to fear of discipline by the medical board); Robyn S. Shapiro, *Health Care Providers' Liability Exposure for Inappropriate Pain Management*, 24 *J. Law, Medicine & Ethics* 360, 363 (Winter 1996) (identifying fear of legal penalties, especially disciplinary action, as one of the most important reasons health professionals undertreat pain. 69% of California physicians acknowledge that the potential for disciplinary action made them more conservative in their use of opioids in pain management).

² Emanuel EJ; Daniels ER; Fairclough DL; Clarridge BR. The practice of euthanasia and physician-assisted suicide in the United States: Adherence to proposed safeguards and effects on physicians. *JAMA* 1998;280(6):507-13. Meier DE; Emmons CA; Wallenstein S; Quill T; Morrison RS; Cassel CK. A national survey of physician-assisted suicide and euthanasia in the United States. *N Engl J Med* 1998;338(17): 1193-201.

Mark R. Wicclair, Ph.D., Professor of Philosophy and Adjunct Professor of Community Medicine, West Virginia University, and Adjunct Professor of Medicine and Instructor in the Bioethics Program, University of Pittsburgh.

Bob Arnold, Section of Palliative Care and Medical Ethics, University of Pittsburgh Medical School.

Glen McGee, Ph.D., Center for Bioethics, University of Pennsylvania.

Ernie W.D. Young, Ph.D., Professor of Ethics, Stanford University School of Medicine, and Co-Director, Stanford University Center for Biomedical Ethics.

Ben A. Rich, J.D., Ph.D., Associate Professor, Bioethics Program, University of California at Davis Medical Center.

Kathy L. Cerminara, Assistant Professor, Shepard Broad Law Center, Nova Southeastern University.

Kenneth Kipnis, Ph.D., Professor of Philosophy, University of Hawaii at Manoa. Elaine Morgan, M.D., Associate Professor of Pediatrics, Hematology/Oncology, Children's Memorial Hospital, Northwestern University.

David Orentlicher, M.D., J.D., Samuel R. Rosen Professor of Law, Co-Director, Center for Law and Health, University School of Law-Indianapolis.

Joan C. Callahan, Professor, Department of Philosophy, and Director, Women's Studies Program, University of Kentucky.

Judith A. Erlen, Ph.D., RN, Professor, University of Pittsburgh, School of Nursing.

Gregory Pence, Professor, School of Medicine and Department of Philosophy, University of Alabama at Birmingham.

Dr. Erich H. Loewy, Professor and Endowed Alumni, Association Chair of Bioethics, University of California at Davis.

James W. Walters, Ph.D., Ethicist, Loma Linda University.

Gerald Dworkin, Professor of Philosophy, University of California at Davis.

Kenneth W. Goodman, Ph.D., Director, Bioethics Program, University of Miami.

Timothy F. Murphy, Ph.D., Associate Professor, University of Illinois College of Medicine at Chicago.

Joel Frader, M.D., Associate Professor of Pediatrics and Associate Professor of Medical Indiana Ethics and Humanities, Northwestern University Medical School, and Medical Director, Pediatric Palliative and Hospice Care Program, Children's Memorial Hospital.

Charles W. Lidz, Ph.D., Research professor of Psychiatry, University of Massachusetts Medical School.

Robert D. Truog, M.D., Professor of Anesthesia, Professor of Medical Ethics, Harvard Medical School.

Yale Kamisar, Professor of Law, University of Michigan.

Jeffrey Kahn, Ph.D., M.P.H., Director, Center for Bioethics, University of Minnesota.

Steve Miles, M.D., Professor of Medicine, Geriatrics, and Bioethics, University of Minnesota.

Rebecca Dresser, J.D., Professor of Law and Ethics in Medicine, Washington University Law School.

Rob Schwartz, Carl Hatch Professor of Law and Professor of Pediatrics, University of New Mexico.

Bonnie Steinbock, Department of Philosophy, University of Albany, State University of New York.

Maxwell J. Mehlman, Arthur E. Petersilge Professor of Law, Director, The Law-Medicine Center, Case Western Reserve University School of Law, and Professor of Biomedical Ethics, Case Western Reserve University School of Medicine.

Norman Daniels, Department of Philosophy, Tufts University.

Adrienne Asch, Ph.D., M.S., Henry R. Luce Professor in Biology, Ethics, and the Politics of Human Reproduction, Wellesley College.

Leonard M. Fleck, Ph.D., Professor of Philosophy and Medical Ethics, Michigan State University.

David J. Mayo, Ph.D., Faculty Associate, Center for Bioethics, University of Minnesota, and Professor, Department of Philosophy, University of Minnesota—Duluth.

Norman L. Cantor, Professor of Law and Justice, Nathan Jacobs Scholar, Rutgers Law School, Newark.

Samuel Gorovitz, Ph.D., Professor of Philosophy and Public Administration, Syracuse University.

Rosamond Rhodes, Ph.D., Director, Bioethics Education, Mount Sinai School of Medicine.

Professor R.G. Frey, Department of Philosophy, Bowling Green State University.

Leslie Pickering Francis, Professor of Philosophy and Professor of Law, University of Utah.

Dan W. Brock, Ph.D., Charles C. Tillinghast, Jr. University Professor, Professor of Philosophy and Biomedical Ethics, Director, Center for Biomedical Ethics, Brown University,

John D. Arras, Porterfield Professor of Bioethics, University of Virginia.

Albert R. Jonsen, Ph.D., Professor of Law and Medical Ethics, School of Medicine, University of Washington.

Margaret P. Battin, Ph.D., Distinguished Professor of Philosophy and Adjunct Professor of Internal Medicine, University of Utah.

R. Alta Charo, J.D., Professor Emeritus of Ethics in Medicine, University of Wisconsin Law School.

OREGON HOSPICE ASSOCIATION,
April 25, 2000.

COMMITTEE ON THE JUDICIARY,
U.S. Senate.

CHAIRMAN HATCH AND MEMBERS OF THE COMMITTEE: I am submitting testimony today on behalf of the Oregon Hospice Association (OHA), which opposes the Pain Relief Promotion Act of 1999 (PRPA), and of the Task Force to Improve Care of Terminally Ill Oregonians (ICTIO) and the Physician Orders for Life Sustaining Treatment Task Force (POLST), both of which have grave concerns.

OHA is a charitable, public benefit, not-for-profit membership organization dedicated to ensuring that all Oregonians have access to high quality hospice and comfort care. OHA is one of the few secular organizations that opposed the Death With Dignity Act in 1994 and supported its repeal in 1997. It no longer matters whether we think physician-assisted suicide is right or wrong. It is the law here and we support the right of dying Oregonians, including our patients, to access all of their legal end-of-life options.

ICTIO and POLST task forces are made up of 26 and 22 individuals respectively, representing public and professional organizations, public and private medical centers, state boards, and governmental agencies involved with health care. The task forces are neutral in respect to physician-assisted suicide. Their statements of concern about the PRPA and lists identifying members are attached. I represent OHA on both.

We are uniquely qualified to speak to provisions within the PRPA. Few Americans have given as much thought or have taken as much action as we have, in our independent organizations and in the task forces, towards both achieving excellence in end of life care and incorporating physician-assisted suicide into the end of life care continuum. Responsibly. Successfully. When we say that the Pain Relief Promotion Act of 1999, with or without the Hatch Substitute Bill, will have a chilling effect on the prescribing practices of physicians for pain and symptom management, you should listen.

We can understand that you want to believe the PRPA will both stop physician-assisted suicide in Oregon and improve pain and symptom management at the end of life. But our experience will not allow us to believe that a law that will (1) judge the intent of a physician and (2) add more regulatory scrutiny to a problem caused by what is already too much can fix the problems that have led to the epidemic of pain in the United States. That just the prospect of federal action has had a negative impact in Oregon supports our belief. Since late 1997, the perceived risk of an investigation—and an investigation itself, whether it leads to conviction or acquittal, can have a devastating effect on a physician's livelihood—has been increased by, first, the letter from Mr. Constantine of the DEA, when the law was finally implemented. Immediately following Ms. Reno's decision that the DEA did not have the authority to prosecute physicians for prescribing a lethal prescription, the Lethal Drug Abuse Prevention Act of 1998 (LDAPA) was introduced. When the LDAPA was abandoned, the threat continued with the introduction of the PRPA in 1999. We've been able to measure the impact.

Coincidentally, family members were interviewed about the deaths of loved ones occurring throughout 1997, as part of an Oregon Health Sciences University Ethics Center research project on end-of-life care. During late 1997, when the Death With Dignity Act was implemented and these threats began, the reported rate of moderate to severe pain and suffering during the last week of life increased significantly in the hospital setting. The reported rate of moderate to severe pain at home or in nursing homes remained stable at approximately 30 percent throughout the year,

the same rate as was reported in hospitals for the first nine or ten months.^{1 2} The ICTIO task force recently previewed new data supporting these conclusions that will be released in a report in May or June. It is my understanding that some of this information will be made available to the Committee. I hope you will take time to recognize its significance.

Of interest too, is the sharp downward turn of Oregon's morphine consumption rate graphed early in 1998, which would reflect a decreased usage of morphine late in 1997—and constitute further evidence of the chilling impact on physician prescribing practices. This information is also being made available to you.

As you are asked to consider data relative to pain and morphine consumption—and the impact of PRPA—like state laws, you should be aware of the following:

- A rate of moderate to severe pain of 30 percent is unacceptable in Oregon, or anywhere else. However, the lowest reported pain in any previous study conducted in the United States was 50 percent. A 1994 AHCPR report revealed that two-thirds of cancer pain and half of all post-operative pain in the country was under-treated.³ Unfortunately, there is little evidence that these numbers have changed significantly in the past seven years.
- Oregon's rate of morphine use is consistently higher than the national average, even when it has been "depressed". In 1998, Oregon finished out the year in sixth place at 3,580 grams/100,000 population. Oregon was second in 1999, at 4,044, behind New Hampshire at 4,200, although Oregon was first in the first three quarters. The national average in 1998 was 2,400 grams; in 1999, 2,468. In 1996, the national average was half of that at 1,267 grams.
- In April, 1998, Oregon was recognized as the national leader in end of life care by the Robert Wood Johnson Foundation under their State Initiatives in End-of-Life Care programs. Hospice penetration in Oregon, the number of hospice deaths compared to total deaths, is 32 percent, probably second highest in the nation behind Arizona. Access to hospice in Oregon, even in rural and remote areas of the state, is close to 100 percent. Although hospices in Oregon do not turn away patients because of an inability to pay, only 1 percent of hospice patients in Oregon are uninsured or without resources.⁴ The hospital death rate is the lowest in the country at 30 percent. The death rate at home and in nursing homes is the highest at 31 percent each. Health care costs in Oregon are the lowest in the country, although satisfaction rates are high. Respect of health care wishes is very high, and with the POLST form, at close to 100 percent.⁵ The SUPPORT study of five medical centers throughout the country revealed no correlation with what a patient said they wanted and with what they got.^{4 5 6}

The Oregon Hospice Association entered the public debate over physician-assisted suicide to offer a moderate and objective voice to the discussions, to help separate out the logical arguments from the emotional. As a secular organization, OHA is not bound by religious considerations, although ethical considerations are of importance. Our goal was to educate, to do what we could to assure that it was a well-informed Oregonian who voted in November. We did not want Oregonians to believe that physician-assisted suicide was the best response to fears of pain, of dying alone or in poverty, of being kept alive hooked up to machines, or of losing their dignity.

The testimony you hear today will likely touch on all of those.

You will hear that proponents of physician-assisted suicide misled Oregon voters by claiming that the Death with Dignity Act was needed to prevent pain and suffering, but that those who have chosen physician-assisted suicide have not been in pain.

When I say that Oregon has implemented physician-assisted suicide responsibly, I cite the fact that Oregonians are *not* choosing physician-assisted suicide because of pain or any other symptoms we can fix. The fear of pain was a major reason Oregonians voted for the Death With Dignity Act and a major reason why they begin the process of determining eligibility. But when they are getting the kind of care

¹ Tolle S., Haley K. Pain management in the dying: successes and concerns. Fall Issue of BME Newsletter, 1998.

² The Oregon Report Card: Improving Care of the Dying. Center for Ethics in Health Care. OHSU, 6/99.

³ Management of Cancer Pain. Clinical Practice Guideline, Number 9. Agency for Health Care Policy and Research, March 1994.

⁴ Using qualitative and quantitative data to shape policy change. Focus: Oregon, State Initiatives in End-of-Life Care, Issue 1, June 1998.

⁵ Oregon Hospice Association data.

⁶ The SUPPORT Principal Investigators. Controlled trial to improve the care of seriously-ill hospitalized patients. JAMA 1995; 274: 1591-1598.

they need, 46 percent of those who request a lethal prescription never use it.⁷ Whether they need physician-assisted suicide or not, they perceive that they may need it. “A man who fears suffering is already suffering is already suffering from what he fears.”⁸

That Oregonians voted for physician-assisted suicide even when they were assured that all physical and emotional pain at the end of life can be treated reflects a level of trust that will further be compromised if the PRPA is passed. Making physician-assisted suicide illegal is not the only way to discourage it. Congress would be far more constructive if it eradicated the barriers it’s erected that compromise access to hospice and palliative care, to home health care, and to medication. What good is a prescription for pain medication, if the patient can’t afford to fill it?

You will hear testimony that physician-assisted suicide devalues the disabled, the sick, the elderly, and the poor, Conferring value on these populations is an admirable—and achievable—goal, but not one Congress can do by passing the PRPA. Physician-assisted suicide is a response to the fears of losing independence, of being unable to get needed care or medicine, of outliving resources, or of impoverishing families. These are the problems we’ve been unable to fix in Oregon, as health care professionals, and these are the reasons most Oregonians have given for choosing physician-assisted suicide. These reasons will remain whether or not physician-assisted suicide is allowed in Oregon or any where in America. Congress can fix those problems, if it has the courage to redistribute some of the enormous wealth that only some of the country enjoys.

You will hear testimony that, contrary to our claims that the PRPA will have a negative impact on pain management, pain management has improved in those states who have already passed PRPA-like laws. Louisiana has been cited as an example. In 1996, morphine consumption in Louisiana was less than 1,621 grams per 100,000 population. In 1998, Louisiana was ranked 41st in the nation at 1,973 grams. In 1999, Louisiana dropped to 42nd place at 1,890 grams. Kansas was 39th in 1998 at 2,016, and went up slightly to 32nd in 1999 at 2,179. Rhode Island was 24th in 1998 at 2,480 and 40th in 1999 at 2,018. Rhode Island’s consumption rate in 1996 was less than 972 grams. Virginia was 33rd in 1998 at 2,106 and 27th in 1999 at 2,401, a very modest gain.

Texas has been cited as an example of a state that was not harmed by PRPA-like legislation. But if morphine consumption is even a crude indicator, PRPA-like legislation cannot overcome the barriers created by restrictive state multiple copy monitoring laws. In 1999, at 1,834 grams, Texas remained at 45th in the nation, in 1998 they were at 1,844 grams. None of the six or seven states with such “hassle” laws has risen above average in morphine consumption. New York, which has recently switched to electronic monitoring is 39th at 2,044; Texas is 45th; Idaho is 47th at 1,761; Illinois is 48th at 1,663, (up from 51st in 1998); and Hawaii is 51st at 1,607.

It’s interesting to look at morphine consumption, too, from another perspective. Oklahoma is ranked 30th in 1999 and 34th 1998 at 2,137 and 2,186, respectively. Utah is 44th at 1,840, up from 48th in 1998, although Utah’s large population of children can at least partially explain the low rate. Senator Nickles and Senator Hatch and Congressman Hyde have reason to be worried about pain management in their states. The PRPA, however, is not likely to have the impact they’d like. Ohio, incidentally, is ranked 41st in 1999, at 1,980, down from 37th in 1998.

Morphine consumption rates have been increasing significantly throughout the country. The question is, what rate should we be aiming for? Is Oregon’s rate at over 4,000 grams per 100,000 population high enough? No, it’s not if 30 percent of Oregonians, or more, experience pain in their last week of life. If Oregon’s rate is even close to high enough, it still means that nearly every other state needs to increase their rate by 50% or 100% or 400%.

Restrictive state prescribing laws and harsh state medical board policies have already created unnecessary barriers to adequate pain management. It’s time to abolish the kinds of laws and regulations that perpetuate the myth that controlled substances are unusually dangerous drugs, not to create more. “Just say no!” isn’t always the right answer.

By trying to draw an arbitrary line between what is killing the patient and what is killing the pain, and by basing that line on something as ephemeral as a doctor’s intent, the PRPA will create another barrier—an incentive and another excuse for a physician to under prescribe controlled substances. When erring on the side of

⁷ Ganzini L., Nelson HD, Schmidt TA, Kraemer DF, DeLorit MA, Lee MA. Physicians’ experiences with the Oregon Death With Dignity Act, *N Engl J Med* 2000; 342:557–63.

⁸ Essayist Michel de Mantagne.

caution reduces his or her risk of an investigation to virtually zero, it will be the patient that will lose.

We haven't talked much about what kind of impact the PRPA, if passed, might have on the public.

In fact, the patient, and their family, is unlikely to win. On one side, the patient and their family will experience unnecessary pain, but because most people believe that death is of necessity a painful experience, they'll be unlikely to report a physician for under prescribing. On the other side, the patient and their family will more likely experience an invasion into their grief, if a pharmacist, a nurse, a family member, or a neighbor, triggers an investigation because he or she is alarmed at the amount of drugs prescribed or suspicious about a death that follows soon on the heels of a prescription. Death investigations, no matter how sensitive, are painful experiences for a bereaved family. We've had that experience here in Oregon, too.

While I've testified as a health care professional, I am well qualified, too, to testify from a personal perspective. I have had multiple sclerosis (MS) since I was a teenager. I am able to work now, almost without restriction, thank God, but there have been times in my life when I was unable to see or unable to walk. I was my fiance's caregiver in 1996, when he died in California. Until he was admitted to hospice, I was the one who navigated California's restrictive prescribing laws, obliterating the artificial barriers he encountered in getting his pain managed. Had I not been there as an advocate, with my knowledge about pain and symptom management, the course of his illness would have been very different. And I am an "older" American, who is assuming more and more responsibility for my elderly mother and sister and brother-in-law, who are both disabled. My mother's pride and her need for independence have kept her from asking for—or accepting—help. I thought she was being penny-wise and pound foolish when she took only half of her pain medication! The fact is that old age and disability have severely depleted her resources. She can no longer afford, on her own, to get her prescriptions filled!

Twenty years from now, when I'm in her boat, I'll look back on this time as if it were yesterday.

Respectfully submitted,

ANN JACKSON, *Executive Director/CEO,*
Oregon Hospice Association.

PHYSICIAN ORDERS FOR LIFE-SUSTAINING TREATMENT TASK FORCE

CONCERNS REGARDING UNINTENDED CONSEQUENCES OF THE PAIN RELIEF PROMOTION ACT (HYDE/NICKLES BILL)

Since 1991, the Physician Orders for Life-Sustaining Treatment (POLST) Task Force has endeavored to help health care providers honor patient wishes for life-sustaining treatments. The group, comprised of 22 individuals representing 14 health care organizations, has developed and helped implement the POLST document in health care organizations and communities ensuring respect for patient preferences at the end of life. The document includes orders regarding CPR, other services provided by emergency medical services, antibiotics, and use of artificial fluids and nutrition. The Task Force has made special efforts to assure that comfort measures are always provided when life-support is withheld or withdrawn. The program has been promoted by the Institute of Medicine, The Robert Wood Johnson Foundation's State Initiatives in End-of-Life Care, and is included in the Education for Physicians on End-of-Life Care program of the AMA. Although the successful POLST project is specific to Oregon, other states are developing similar programs.

The POLST Task Force has no position on Oregon's Death With Dignity Act and has concerns regarding the Pain Relief Promotion Act proposed by Senator Nickles. The Task Force feels that the threat of investigation or disciplinary action, whether real or perceived, will lead some physicians to prescribe less medication thereby causing more pain and suffering for their dying patients.

POLST TASK FORCE—APRIL 2000

Name and organization

Jerry Andrews, EMT-P, EMS/Multnomah Co. Health Department
Mark Bonnano, JD, Oregon Health Decisions
Ken Brummel-Smith, MD, Long Term Care Div./Providence Health Sys.
Margaret Carley, JD, Oregon Health Care Association
Patrick Dunn, MD, FACP, OHSU/Center for Ethics in Health Care
Dan Field, Oregon Assoc. of Hospitals & Health Sys.
Sally Goodwin, MM, Oregon Alliance of Senior & Health Services

Tim Hennigan, AS, EMT-P, EMS/Multnomah Co. Health Department
 Ann Jackson, MM, Oregon Hospice Association
 Susan King, RN, MS, Oregon Nurses Association
 Mimi Luther
 Dan McFarling, Nursing Facilities/SDSD
 Chris Nelson, RN, MS, OHSU School of Nursing
 Holly Robinson, JD, Legal Services/SDSD
 Trudy Schidleman, RN, (prior Assoc. Director, EMS Services)
 Terri Schmidt, MD, OHSU Emergency Services
 Carmen Spencer, RN, BSN, CBCQI/SDSD
 Virginia Tilden, RN, DNSc, OHSU Center for Ethics in Health Care
 Susan Tolle, MD, OHSU Center for Ethics in Health Care
 Molly Weinstein, JD

JUNE 17, 1999.

In January of 1995, the Center for Ethics in Health Care at the Oregon Health Sciences University convened the Task Force to Improve the Care of Terminally Ill Oregonians. The Task Force is a consortium of health professionals, organizations, agencies and institutions which seek to promote excellent care of the dying and to address the ethical and clinical issues posed by the enactment of the Death With Dignity Act. While individual Task Force members and the organizations they represent have differing views and values regarding physician assisted suicide and the Death With Dignity Act, the Task Force has endeavored to maintain a neutral position on these issues. The Task Force is comprised of 24 agencies and organizations, all of whom support the goals of quality pain management and promoting excellence in care of the dying. A list of Task Force members, member organizations is attached.

"The Task Force to Improve the Care of Terminally Ill Oregonians is concerned that the Nickles Bill will have a negative impact on pain and symptom management at end of life."

TASK FORCE TO IMPROVE THE CARE OF TERMINALLY-ILL OREGONIANS—JUNE 1999

Name and organization

Frank J. Baumeister, Jr., MD, Oregon Medical Association
 Joan Bouchard, RN, Oregon State Board of Nursing
 Margaret Carley, JD, RN, Oregon Health Care Association
 Patrick M. Dunn, MD, Oregon Health Sciences University
 Tony Farrenkopf, PhD, Oregon Psychological Association
 Dan Field, JD, Oregon Assoc. of Hospitals & Health Systems
 Linda Ganzini, MD, Oregon Psychiatric Association
 Lyn Glenn, RN, BSN, OCN, Oncology Nursing Society
 Kelly T. Hagen, JD, Health Law Section, Oregon State Bar
 Kathleen Haley, JD, Director, Board of Medical Examiners
 Katrina Hedberg, MD, Oregon Health Division
 Susan Hedlund, LCSW, National Assoc. of Oncology Social Workers
 Ann Jackson, MM, Oregon Hospice Association
 Teresa Kraemer, RN, JD, Oregon Alliance of Senior & Health Services
 Pam Matthews, RN, BSN, CHCE, Oregon Association for Home Care
 Sherry Moore, RN, Oregon Nurses Association
 Bonnie Reagan, MD, RN, Adventist Medical Center
 Robert Richardson, MD, Kaiser Permanente Ethics Service
 Terri Schmidt, MD, MS, Tri-County EMS Physician Supervisors Group
 Gary Schnabel, RN, RPh, Oregon State Pharmacists Association
 Joseph Schnabel, Pharm.D., Board of Pharmacy
 Martin Skinner, MD, Oregon Medical Association
 Susan W. Tolle, MD, Director, Center for Ethics in Health Care
 Fr. John Tuohey, Providence St. Vincent Health System

The CHAIRMAN. Senator Smith.

**STATEMENT OF HON. GORDON SMITH, A U.S. SENATOR FROM
 THE STATE OF OREGON**

Senator SMITH. Thank you, Mr. Chairman, members of the committee. I thank you for granting my request and that of my colleague, Ron Wyden, to hold this hearing today. There are good peo-

ple on both sides of this very controversial and emotional issue of assisted suicide, but I think given the importance of the issue, we can all be united in the belief that it deserves the full and fair hearing and process every step of the way.

Mr. Chairman, this is a difficult day for me, but I am glad I am seated with my colleague, Ron Wyden. It is a matter of Senate history that he and I fought a very difficult campaign against one another, but ultimately we became colleagues, but more, we have become friends, and my pledge to him is that that will continue on my part, even while we differ on the ultimate vote in this case.

Mr. Chairman, I am going to read my statement and ask that it also be included as part of the permanent record.

The CHAIRMAN. Without objection, it will be.

Senator SMITH. I do this in order that I might get through this in a way intelligible to you.

The debate over physician-assisted suicide is a relatively new one in the halls of Congress and throughout most of the country, but this is not the case in my State of Oregon. Indeed, Oregon's debate began in earnest at about the same time I began my public service as an Oregon State Senator in 1993. In 1994, 51 percent of Oregon voters approved an initiative allowing physician-assisted suicide, and in 1997, 60 percent of Oregon voters chose not to repeal that decision.

The first initiative made the matter of assisted suicide a central concern to voters in my two campaigns for election to the U.S. Senate in 1996, and the second initiative vote has made it a central concern to Oregonians throughout my years of service in this body.

It is no exaggeration to say that my views on the subject were sought at every campaign stop prior to my election and have been sought at every town hall since my election. On hundreds upon hundreds of occasions, my answer was always and is always without variance. I am opposed to physician-assisted suicide.

Today, I come before this committee to repeat that answer once again. Mr. Chairman, I am acutely aware that this position places me at odds with the majority of my constituents and I tell you that it is a lot more comfortable to be with the majority in the business of democracy. For that reason, I admit to having wrestled for a different conclusion in this issue in order that I might once again take comfort in the crowd. But on a matter of this magnitude, a matter of life and death, I have failed to find comfort with a troubled conscience. But more, I am loathe to let down the hundreds of thousands of Oregonians who, though a minority, heard my answers and now count on the integrity of my words.

And so, Mr. Chairman, recognizing that this places me in conflict with a majority of my constituents but at peace with my conscience, I am here today to urge the passage of the Pain Relief Promotion Act. I am also here today to say that while on this issue I cannot give Oregon's majority my vote, I owe them an explanation.

Prior to my service in elected office, I served on a volunteer basis as a bishop of the Church of Jesus Christ of Latter-Day Saints in my hometown. In this capacity, I found my professional work as a food processor in a constant but blessed state of interruption. On a weekly basis and at the oddest of hours, I found myself making

continual rounds at St. Anthony's Hospital in Pendleton, OR. On many occasions, I shared with parents the unspeakable joy of welcoming newborn babies into this world. On other occasions, I suffered heartbreaking sorrows as I tried to comfort the critically ill or hold the hands of those who lay at the brink of eternity.

In my life, I have never dealt with an issue that fills me with more joy, more sorrow, and more reverence than does the sanctity of life. Through my experiences at that hospital, I came to believe as never before that men and women are not just advanced animals but are children of divine origin and are here on earth to have all of life's experiences, good and bad, pleasure and pain, health and sickness.

I further believe that there is a natural course to living and dying, and that with some exceptions, we should not shorten life or lengthen life by artificial or invasive means. That is a belief instilled in me during many hours that I spent on one occasion with a dying woman. She had effectively died hours before, but because of invasive high technology that provided artificial respiration, nutrition, and hydration, and because of physician fear over liability, her death, not her life, was prolonged for many hours.

It is precisely because of these beliefs and my experiences that I did the unexpected when I became an Oregon State Senator. To the chagrin of a few in the pro-life community, I coauthored one of the most liberal advanced directive laws in the United States. Because of the role that I played, Oregonians now have the right to refuse artificial respiration, nutrition, and hydration in terminal circumstances. Moreover, physicians can honor these requests secure in the protection of law.

I viewed then and still view the withholding of extraordinary medical measures as an act of omission, an appropriate acquiescence to the timetable of nature's God. But I stated then and believe still that physician-assisted suicide is an act of commission, a step over the line, a step in which the State should never have complicity. It is the line of commission rather than omission that I cannot cross. I believe the United States should never cross the line, either, by allowing federally controlled substances to be used in physician-assisted suicide. To do so would be bad policy and it would have consequences over time unimaginable now. But what are these consequences?

An Oregonian by the name of Derrick Humphries makes this clear. He is one of the most vocal and visible advocates of assisted suicide and he has written a book in 1998 called *The Freedom To Die*. In the final chapter of Mr. Humphries' book, it is entitled, "The Unspoken Argument." Why is it unspoken? Because it is so awful.

Let me quote from page 313 of Mr. Humphries' book, where he reveals the true reason why he believes assisted suicide's time has come. "One must look at the realities of increasing costs of health care in an aging society, because in the final analysis, economics, not the quest for broadened individual liberties or increased autonomy will drive assisted suicide to the plateau of acceptable practice." Then he asks this chilling question. "Is there, in fact, a duty to die, a responsibility within the family unit that should remain voluntary but expected nevertheless?"

Mr. Humphrey answers yes, but I believe we must answer his vision of Orwellian ugliness with a resounding no. I will not be party to building such a society or justifying such a culture of death. In such a culture, we should never wonder why children do not value life when adults write laws that do not value it, either.

The right to kill one's self is a private right. It is a right that can be exercised in nearly everyone's medicine cabinet. But it is dangerous to make doctors and the State complicit in killing, even though consensual. In an age of medical rationing and for-profit HMO's, there is a terrible ethical and financial conflict of interest, and the Federal Government should see it and stay away from it. Where Mr. Humphries sees a duty to die, I see a duty to resolve the shortcomings of our medical budgets rationally and honestly without sacrificing the most vulnerable of our society, the elderly and the disabled, to some newfangled duty to die.

Now, finally, Mr. Chairman, let me turn to the issue of States' rights. At the heart of Oregon's twice-passed physician-assisted suicide law is the assumption that Oregon can change, expand, or interpret a 30-year-old Federal statute in ways never authorized or contemplated by the national government. Not since Lee's army surrendered to Grant at Appomattox Court House has any State enjoyed such a right. The Controlled Substance Act was passed expressly to control deadly drugs in interstate commerce to ensure "public health and safety." It was the toxic and lethal nature of these drugs that caused Congress to act, to limit and regulate their use to "legitimate medical purposes."

For a State, even my beloved State of Oregon, to unilaterally act to use Federal drugs for lethal purposes is an open invitation to the nation to reclaim and reassert its law. Oregon has no more right to write Federal law than the Federal Government has to write Oregon law.

Mr. Chairman, I do not know if I will ever have to cast my vote on the Pain Relief Promotion Act, but if I do, Oregonians know that I will answer aye. I would not do so had the bill's sponsors not honored my request to include two important provisions which had not been included in earlier drafts, first, a provision to protect those doctors who may already have aided in the death of a patient, acting in good faith and within their understanding of Oregon's law, and second, a provision that provides physicians with the protection of law so that they may aggressively relieve pain.

With the inclusion of these provisions, I believe the Pain Relief Promotion Act will free up physicians to relieve pain and suffering as never before, with the right to use federally controlled substances in massive amounts even if death is thereby hastened.

Mr. Chairman, this weekend, I will return to Oregon and begin again the process of discussing this issue and my position with those citizens who have granted me the high privilege of serving my native State in the United States Senate. I deeply respect the fact that I do answer to them. I will share with them words that have given me courage throughout my years of public service, but most especially during this past weekend in drafting this statement.

The words are these. "Democracy means much more than popular government and majority rule," wrote John F. Kennedy. "The

true democracy, living and growing and inspiring, puts its faith in people, faith that the people will not simply elect men who will represent their views ably and faithfully, but also elect men who will exercise their conscientious judgment, faith that the people will not condemn those whose devotion to principle leads them to unpopular courses but will reward courage, respect honor, and ultimately recognize right." Thank you, Mr. Chairman.

The CHAIRMAN. I want to thank both of you. They are both very good statements from two very highly respected Senators, both representing your State in the best way you can. This is a difficult set of issues and we are going to have to work our way through them. But I want to thank you both for being here, and Senator Nickles, as well, who had to leave early. Thanks so much.

Our panel number two will consist of Eric Chevlen, M.D. He is the Director of Palliative Care in the Cancer Care Center of St. Elizabeth Medical Center in Youngstown, OH. Dr. Chevlen supports the Nickles legislation and actually wrote a letter to the editor in the Journal of American Medicine in favor of the bill.

Arthur Caplan, Ph.D., he is with the Center for Bioethics for the University of Pennsylvania Health System in Philadelphia. Dr. Caplan is one of the minority witnesses and he opposes the Nickles bill because he believes that the legislation could hinder doctors from aggressively treating pain.

Rabbi J. David Bleich is a professor at the Benjamin Cardozo School of Law and a professor of law and ethics at Yeshiva University. He is testifying on behalf of the Union of Orthodox Jewish Congregations of America and he is strongly in favor of the Nickles legislation.

Kathleen Foley, M.D., works for the Memorial Sloan-Kettering Cancer Center and is strongly opposed to the Nickles legislation. She is a devout Catholic. However, she believes that this legislation will send the wrong message to drug regulators, physicians, and patients about the medical use of controlled substances. She believes that the bill provides inadequate funding for pain care management training and education and that it does not take into account any of the Institute of Medicine of the National Academy of Sciences recommendations on how to improve end-life care.

Walter Hunter is the Associate Medical Director for the VistaCare Hospice in Indianapolis. He, too, is a strong supporter of the Nickles legislation and Dr. Hunter testified at the House hearing on this bill last year.

We will turn the time over to you first, Dr. Chevlen, and go across the table.

STATEMENTS OF ERIC CHEVLEN, M.D., DIRECTOR OF PALLIATIVE CARE, CANCER CARE CENTER, ST. ELIZABETH HOSPITAL, YOUNGSTOWN, OH; ARTHUR L. CAPLAN, DIRECTOR, CENTER FOR BIOETHICS, AND TRUSTEE PROFESSOR, UNIVERSITY OF PENNSYLVANIA, PHILADELPHIA, PA; RABBI J. DAVID BLEICH, ON BEHALF OF THE UNION OF ORTHODOX JEWISH CONGREGATIONS OF AMERICA, WASHINGTON, DC; KATHLEEN FOLEY, M.D., ATTENDING NEUROLOGIST, MEMORIAL SLOAN-KETTERING CANCER CENTER, NY, NEW YORK; AND WALTER R. HUNGER, M.D., ASSOCIATE NATIONAL MEDICAL DIRECTOR, VISTACARE HOSPICE, INDIANAPOLIS, IN

STATEMENT OF ERIC CHEVLEN

Dr. CHEVLEN. Thank you. Mr. Chairman, members of the Senate Judiciary Committee, thank you for inviting me to address you this morning to explain why the Pain Relief Promotion Act should be adopted as law.

Allow me to introduce myself and explain my interest in this bill. My name is Eric Chevlen. I am a physician practicing in Youngstown, OH. My specialties are medical oncology and pain medicine, and I also serve as medical director for two hospices. I am certified by the American Boards of Medical Oncology, Pain Medicine, and Hospice and Palliative Medicine.

Every day in my practice, I face the challenge of relieving the suffering of my patients. One of my best tools in this humane task is the class of drugs we physicians call opioids and which this legislation refers to as narcotics. I prescribe them without hesitation to patients for whom they are the best analgesic. I prescribe them in doses that best balance side effects and benefits no matter what the number of milligrams may be. Given the nature of my practice, it is not a surprise that I am one of the largest prescribers of opioids in Ohio. To borrow a phrase from the world of business, I am the end user of this proposed legislation.

There is one other thing you ought to know about me, Senators. I am opposed to legalized euthanasia and physician-assisted suicide. The reason is this. In over 20 years of practicing medicine, more than a few of my patients have asked me to kill them. In every case, every case, the request stemmed from depression or anguish or desperation or fear of abandonment.

In other words, my terminally ill patients sought euthanasia or assisted suicide for the same reasons that healthy people seek them, and as in the case of healthy people, their suffering could be palliated and their longing for death quelled by proper use of medicine, loving kindness, and what some have called the ministry of presence. The answer to anguish and desperation is not to coldly dispatch the anguished and the desperate, but rather to enfold them within the bonds of the community that sees them intrinsic rather than merely utilitarian value.

I am opposed to euthanasia and I favor the passage of the PRPA because it ends Federal collusion in the nasty business of doctors killing their patients. Nevertheless, Senators, if the PRPA were somehow to diminish the capability of physicians to relieve the suffering of the dying, if it were to increase the risk of harassment by over-weening bureaucrats, or even if it were to chill the ardor of

physicians to relieve suffering because they misunderstood the bill, if any of these were the case, then I would not be here speaking in support of the bill. Indeed, I would likely be here speaking against it.

Such, however, is not the case. The PRPA would not diminish the ability of doctors to relieve suffering of the dying or others in pain. It is likely, frankly, that it would improve their ability to do so.

Now, opponents of the PRPA argue that its language will have a chilling effect on the willingness of doctors to prescribe adequate doses of opioids to relieve the pain of dying patients, that they will fear a meddlesome DEA bureaucracy eager to swoop down on them and throw them in jail for 20 years when poor grandma dies of cancer after her final comforting doses of morphine.

Senators, the law today, as it has been for 30 years, is that a controlled substance may not be used intentionally to kill a patient. The PRPA does not create a new limitation on use of opioids to relieve pain. Quite the contrary. This bill puts into statute what has heretofore been only administrative guideline, namely that it is legitimate medical purpose to use a controlled substance to relieve pain even if that use increases the risk of death. By the way, it does not.

This doctrine of double effect will remain the law in 49 States whether the PRPA passes or not. Making it explicit by statute should increase, not decrease, physicians' comfort in prescribing the opioids. In fact, this increase in morphine use and other opioid use was seen in six States which adopted laws similar to the PRPA, and that is shown on some of the posters which are available at the sides of the chamber, and perhaps an aide can put them up. I request that those be entered into the record, Mr. Chairman.

The CHAIRMAN. Without objection.

[The information of Dr. Chevlen is attached to his prepared statement.]

Dr. CHEVLEN. The increased reassurance concerning overweening regulation that physicians crave will not come from defeating the PRPA but rather from passing it. This bill, for the first time, calls for Federal dollars to be spent in the training and education of both Federal and local officials so that they will be more knowledgeable about proper palliative care and less likely to mistake good care for a violation of the law. If the PRPA is not passed, then there is nothing to improve the situation as it now stands, nothing to reduce the regulatory fear that inhibits doctors from prescribing drugs properly.

Gentlemen, when I first earned my Federal license to prescribe controlled substances, I was proud that my country had recognized my competence to relieve the suffering of my fellow citizens and had entrusted to me the privilege to prescribe these medications for their benefit. It is deeply offensive to contemplate how this license of which I was so proud, a license to palliate the misery of my patients and fellow creatures, this license has been degraded now to be a Federal license to kill them, State law permitting—to kill them, State law permitting.

Senators, remove this stain, erase this lot. Vote to improve pain treatment and to protect the vulnerable citizens of this country. Vote to allow honest physicians to relieve pain without the stigma

of a Federal license to kill. Please pass the Pain Relief Promotion Act.

The CHAIRMAN. Thank you so much.

[The prepared statement of Dr. Chevlen follows:]

PREPARED STATEMENT OF ERIC CHEVLEN, M.D.

Mr. Chairman, members of the Senate Judiciary Committee: Thank you for inviting me to address you this morning to explain why the Pain Relief Promotion Act (PRPA) should be adopted as law.

INTRODUCTION

Allow me to introduce myself and explain my interest in this bill. My name is Eric Chevlen, M.D. I am a physician practicing in Youngstown, Ohio. I am the director of palliative care at St. Elizabeth Hospital, and medical director of two hospices. I am certified by the American Board of Medical Oncology, the American Board of Pain Medicine, and the American Board of Hospice and Palliative Medicine. Every day in my practice I face the challenge of relieving the suffering of my patients. One of my best tools in this humane task is the class of drugs we physicians call opioids, and which this legislation refers to as narcotics. I unhesitatingly prescribe them to patients for whom they are the best analgesic, in doses that best balance side effects and benefit, no matter what the number of milligrams may be. Given the nature of my practice, it is not a surprise that I am one of the largest prescribers of opioids in Ohio. To borrow a phrase from the world of business, I am the "end-user" of this proposed legislation.

There is one other thing you ought to know about me. I am opposed to legalized euthanasia and physician assisted-suicide. The reason is this: In over twenty years of practicing medicine, more than a few of my patients have asked me to kill them. In every case—every case!—the request stemmed from depression, or anguish, or desperation, or fear of abandonment. In other words, my terminally ill patients sought euthanasia or assisted suicide for the same reasons that healthy people seek it. And, as in the case of healthy people, their suffering could be palliated, and their longing for death quelled, by proper use of medicine, loving kindness, and what some have called the ministry of presence. The answer to anguish and desperation is not to coldly dispatch the anguished and desperate, but rather to enfold them within the bonds of a community that sees in them intrinsic, rather than merely utilitarian, value.

I am opposed to euthanasia. Nonetheless, Senators, if the PRPA were somehow to diminish the capability of physicians to relieve the suffering of the dying, if it were to increase the risk of harassment by overweening bureaucrats, or even if it were to chill the ardor of physicians to relieve suffering because they misunderstood the bill—if any of these were the case, then I would not be here speaking in support of the bill. Indeed, I would likely be here speaking against it.

Such, however, is not the case. The PRPA would not diminish the ability of doctors to relieve the suffering of the dying or others in pain. It is likely, frankly, that it would improve their ability to do so.

HISTORY OF THE CONTROVERSY

For some thirty years, the Controlled Substances Act (CSA) has regulated the therapeutic use of opioids and other substances. For thirty years, the federal law has recognized that, if misused, controlled substances present a significant potential harm to the public. For thirty years the law has also recognized that, when used properly, they also offer a unique and wonderful relief of suffering.

To minimize the potential harm and to maximize the potential benefit of controlled substances, Congress mandated that they be prescribed only by practitioners who were licensed by the Drug Enforcement Agency. Congress also demanded—and who could argue with this?—that the prescribing of the controlled substances be done only for legitimate medical purposes.

"Legitimate medical purposes." That is a phrase you will hear often today, and whose interpretation—and misinterpretation—is the crux of the issue before us today.

Until quite recently, there was never any argument over the meaning of the term. Every doctor knew that he could not simply sell prescriptions for cash. Every doctor knew that he could not swap prescriptions for sexual favors. Every doctor knew that he could not use prescribed drugs to commit homicide, even if the victim consented or participated in that act.

There was never any question about all this. The meaning of the law was plain, and it was buttressed by numerous uncontroversial court decisions.

This clarity and integrity of the federal law came to an end, however, after the passage of Oregon's notorious physician-assisted suicide law. The question arose: if an Oregon practitioner is in compliance with the admittedly loose requirements of that state law, may he prescribe a controlled substance to kill his patient? The head of the DEA said no: a state law cannot change the fact recognized by federal law, that killing people is simply not a legitimate medical purpose. The Attorney General overruled him. She said, in effect, that in forty-nine states, killing patients was not a legitimate medical purpose, punishable under the Controlled Substances Act. In Oregon, however, it was to be considered a legitimate medical purpose—unless the practitioner failed to fill out the requisite state paperwork. Then, it would again be deemed not legitimate.

USURPING CONGRESSIONAL AUTHORITY

Although that decision certainly generated a lot of discussion, I am surprised at how little has been said concerning what a sweeping Executive branch usurpation of Congressional authority was thereby accomplished. The Attorney General's decision effectively eliminated the Controlled Substances Act. If the impact of the law is to be determined, as she says, by state standards, then there is in effect no longer any enforceable federal standard. Oregon has now empowered its physicians to prescribe lethal doses of controlled substances, and the Attorney General says that if the state permits it, so too does the federal government. In effect, she has created a federal license to kill, if only state law be permitting. There is nothing in her ruling that prevents other states from allowing physicians—or pharmacists or podiatrists for that matter—from prescribing a panoply of controlled substances according to any criteria that state may choose. According to the Attorney General's Alice-in-Wonderland ruling, the federal government must recognize the "legitimate medical purpose" of this, simply because such action would be compliant with that state's law.

This point has been argued, and will surely be argued again if the PRPA does not become law. In 1996, two years before the Attorney General's decision in this case, California passed a law considerably liberalizing the use and distribution of marijuana. In that case, the Justice Department argued the opposite of its point in the Oregon matter, saying, "A state initiative cannot supplant the will of the people of the United States."¹ Later, however, in the Oregon matter, the Attorney General argued that Congress never intended the Controlled Substances Act to apply to such a duly passed state law. Rather, claimed the Attorney General, Congress intended the scope of the CSA to be somewhat limited, and authorized the DEA to prevent the "particular drug abuse" deriving from a drug's "stimulant, depressant, or hallucinogenic effect on the central nervous system."²

Set aside, for a moment, the fact that her theory of the law is completely unsupported by its legislative history, wording, and case law interpretation. Even if one grants the Attorney General's theory, that only drug abuse of this class is interdicted by the CSA, then use of controlled substances to cause death is surely forbidden by the CSA. After all, the very mechanism by which controlled substances in overdose cause death is by depressing the central nervous system, in particular the respiratory center.

Is there to be a uniform federal standard of "legitimate medical purpose" or is there not? If the Senate feels there should not be any standard meaning to a federal law, if it feels that the CSA should be eradicated by bureaucratic legerdemain, then it should not pass the Pain Relief Promotion Act. If, on the other hand, it feels as I do that the very purpose of federal law is to protect the common good by establishing clear and uniform application of the law, then it very much should pass the PRPA. This act has as its main purpose the restoration of a uniform national standard in the Controlled Substances Act, but in fact it would do more: it would prevent the effective elimination of the CSA by the Executive branch without the advice or consent of the Congress.

THE PRPA RESTORES PROPER BALANCE BETWEEN STATE AND FEDERAL LAWS

Much mischief has been made of the fact that the PRPA puts into statute the law as it has been uniformly and unarguably enforced for many years. The act makes explicit that it is only *purposeful* killing of patients that is a violation of the CSA.

¹Justice Department attorney Mark Quinlivan, arguing before U.S. District Court Judge Charles Breyer, quoted by Reuters newservice, March 25, 1998.

²Attorney General Janet Reno, Letter to Congressman Henry Hyde, June 5, 1998.

Gentlemen, that is the law today. Even if the PRPA is not passed, the purposeful killing of a patient by use of a controlled substance will remain a violation of the CSA in forty-nine states. This act does not change the law for the doctors of those forty-nine states. It simply restores the effect of federal law to the one state that has abrogated its duty to extend state interest in the preservation of life to an apparently expendable segment of its population, namely those who are severely ill and despairing of life.

It is also important to note that the PRPA would not overturn the Oregon law allowing physician-assisted suicide. It would still be legal for a practitioner to prescribe a lethal potion there; only it must not contain a federally controlled substance. Sadly, there are a number of other drugs that can accomplish this wicked purpose, and there is no end to the inventiveness of people in whom are mixed the traits of cleverness and contempt for the innate value of every human being. While I believe that passage of the PRPA would diminish the number of victims of medical killing, I do not expect the practice to come to an end in Oregon. The states will retain the right to regulate medical practice within their borders. Passage of the PRPA simply ends federal collusion in the nasty business of doctors killing their patients.

OBJECTIONS TO THE PRPA, AND THEIR REFUTATION

As noted above, there are reasons of both law and justice to pass the PRPA. Now let us review the four possible reasons for opposing it.

First logically, and not last in some opponents' motivation, it would be reasonable to oppose the PRPA if one feels that euthanasia is a public good to be promoted by federal policy. That would be contrary to the unanimous vote in the Senate in denying public funding for euthanasia and assisted-suicide, and contrary to the long history of government protection of vulnerable classes of citizens. But such opposition would be consistent with the effect of the Attorney General's ukase.

The second argument raised against the PRPA is that it diminishes a state's right to regulate the practice of medicine. Even before the inclusion of the amendments introduced by Senator Hatch, this argument held no water, for the bill does not overturn the Oregon act allowing physician-assisted suicide. After the inclusion of the amendments, which specifically declare that "nothing in this subsection shall be construed to alter the roles of the Federal and State governments in regulating the practice of medicine," such an argument is not even worthy of consideration. Unfortunately, physician-assisted suicide will remain legal in Oregon even if this bill is passed. The federal government, however, will no longer play the role of enabler. Actually, if this bill is not passed, the states will gain new and unconstitutional power to limit the right of Congress to control interstate commerce of drugs. Without passage of the PRPA, it is the states that have power of nullification over a federal law. This country has already experienced considerable unhappiness as a result of nullification theory, and the Congress would be ill-advised to resurrect it now.

The third argument against the PRPA is that its language will have a chilling effect on the willingness of doctors to prescribe adequate doses of opioids to relieve the pain of dying patients, that they will fear a meddling DEA bureaucracy eager to swoop down on them and throw them in jail for 20 years when poor Grandma dies of cancer after her final comforting dose of morphine. Since the language of the bill does not adversely affect the license to prescribe opioids in 49 states, this cannot be so. Quite the contrary, this bill puts into statute what has heretofore been only administrative guideline, namely, that it is legitimate medical purpose to use a controlled substance to relieve pain even if that use increases the risk of death. This doctrine of double effect will be the law whether the PRPA passes or not. Making it explicit by statute should increase, not decrease, physician comfort in prescribing opioids.

Opponents of the bill speak as if prosecutors distinguished between homicide and natural death by using a Ouija board, rattles, and feathers. Those of you who have served as prosecutors know how far from reality this is. The circumstances of a death, not the dose of the drug, are determinative. By comparison, in this town of Washington today, two men may die from having a knife stuck in their chests. One case will be an unintended and tragic outcome from a failure to save a patient during a coronary artery bypass operation. The other will be a mugging occurring in an alley near the hospital. Just as it is easy to see that the first death was unintentional and due to a procedure which unavoidably increased the risk of death, so it is easy to see that the second is purposeful and criminal. Deaths associated with opioid use are just as easy to distinguish.

Much mischief is made by the euthanasiasts of the alleged respiratory suppression effect of morphine. Like so much else they promulgate, this is a gross distor-

tion. Experienced clinicians understand that there is an enormous difference between the effect of morphine during its first days of use as compared with its effect in the chronic setting. During the first few days of use, morphine may cause sedation; if used recklessly it may even cause respiratory suppression. But the respiratory system quickly acclimates to morphine therapy. With continued use, morphine—even in high doses—relieves pain, but does not make the patient stop breathing.³

Another source of confusion is the fact that several different pharmacologic classes of drugs are lumped together in the category of controlled substances. Most of our discussion has been about opioids. But opioids are virtually never used to intentionally induce death for the very reason cited above. The recently published data from Oregon shows that 100% of patients who died as a result of prescribed lethal drugs took an overdose of a barbiturate.^{4,5} Only one of the patients was even prescribed an opioid to accompany the barbiturate; in that case the barbiturate alone would clearly have been fatal. With the exception of the antiepileptic phenobarbital, barbiturates have very little legitimate medical use these days. There are much safer drugs available to treat anxiety and insomnia. Indeed, it is this very lack of safety that makes barbiturates attractive to the doctor intent on killing his patient. My point is that this bill should not lead to reduced use of opioids, because opioids are not the drugs used to kill people; barbiturates are.

The opponents of the PRPA may counter that the doctors will refrain from prescribing opioids for fear that DEA or state regulatory officials will misinterpret their use of opioids as intentionally causing death, when in fact the patient died either of natural causes or as an inadvertent effect of the drug. But the law already forbids use of controlled substances to intentionally cause death in forty-nine states. Failure to pass the PRPA will not eliminate this law. The increased comfort concerning overweening regulation that physicians crave will not come from defeating the PRPA, but from passing it. This bill, for the first time, calls for federal dollars to be spent in the training and education of both federal and local officials, so that they will be more knowledgeable about proper palliative care, and less likely to mistake good care for a violation of law. If the PRPA is not passed, then there is nothing to improve the situation as it now stands, nothing to reduce the regulatory fear that inhibits doctors from prescribing drugs properly.

Fourth and finally, we need to address the possible objection to this bill that it will be misinterpreted by doctors, and that their misunderstanding of the bill will lead them to refrain from treating pain adequately. In particular, opponents argue that this misunderstanding will lead to a lower rate of prescribing opioids such as morphine. That opponents of the bill make this argument is actually a stunning concession that the language of the bill itself cannot justify such fears. Let us set aside for a moment the other implication of this argument, that men and women who have spent years mastering the intricacies of anatomy, physiology, pharmacology, and therapeutics are somehow too knuckle-headed to understand the plain meaning of a simple law. This argument of a chilling effect via physician misunderstanding is testable. In fact it has already been tested. Several states have passed laws similar in impact to the PRPA. If the legislation were to have a chilling impact on a doctor's willingness to prescribe opioids, we should see a drop in, for example, morphine consumption in those states subsequent to the passage of the laws.

In fact, the opposite is observed. For example, in the spring of 1996, Louisiana passed a law banning assisted suicide, while allowing pain control that might unintentionally increase the risk of death. Per capita morphine consumption in that state rose 80% that year, and had nearly tripled by two years later. Similar results were seen when Iowa, Rhode Island, Virginia, and Kansas passed similar laws. In fact, of the top ten states in per capita morphine consumption in 1999, seven have specific statutes against assisted suicide.⁶ Now this rise in morphine consumption after passage of state laws resembling the PRPA does not *prove* that such laws improve pain control. But the data certainly *disprove* the contention that such passage will worsen pain control by reducing opioid prescribing.

³P.D. Wall, "The Generation of Yet Another Myth on the Use of Narcotics [Editorial]," *Pain* 73, no. 2 (Nov 1997): 121–2.

⁴Arthur E. Chin, and others, "Legalized Physician-Assisted Suicide in Oregon—the First Year's Experience," *New England Journal of Medicine* 340 (1999): 577–83.

⁵A.D. Sullivan, K. Hedberg, and D.W. Fleming, "Legalized Physician-Assisted Suicide in Oregon—the Second Year," *New England Journal of Medicine* 342, no. 8 (Feb 24 2000): 598–604.

⁶Drug Enforcement Administration, U.S. Department of Justice, Statistics on Individual State Consumption of Morphine.

CONCLUSION: ELIMINATE THE FEDERAL LICENSE TO KILL

Gentlemen, when I first earned my federal license to prescribe controlled substances, I was proud that my country had recognized my competence to relieve the suffering of my fellow citizens, and had entrusted to me the privilege to prescribe these medications for their benefit. It is deeply offensive to contemplate how this license of which I was so proud, a license to palliate the misery of my patients and fellow creatures, has been degraded to be a federal license to kill them, state law permitting. Senators, remove this stain; erase this blot. Vote to improve pain treatment and to protect the vulnerable citizens of the country. Vote to allow honest physicians to relieve pain without the stigma of a federal license to kill. Please pass the Pain Relief Promotion Act.

Use of Pain Control Drugs Rises When States Ban Assisted Suicide

KANSAS

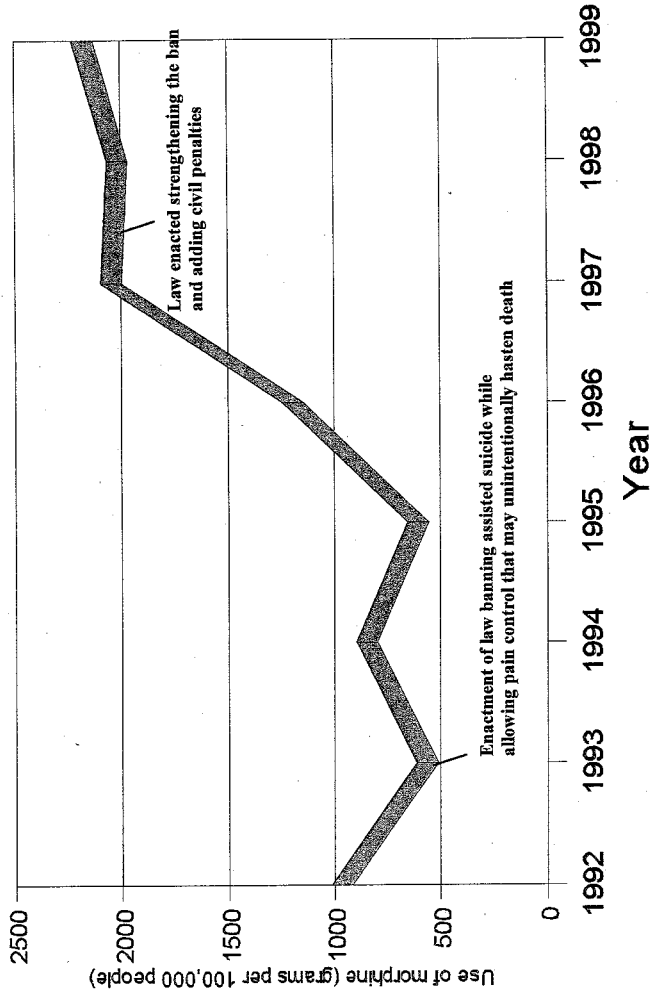

(Source of morphine data: Drug Enforcement Administration)

Use of Pain Control Drugs Rises When States Ban Assisted Suicide

IOWA

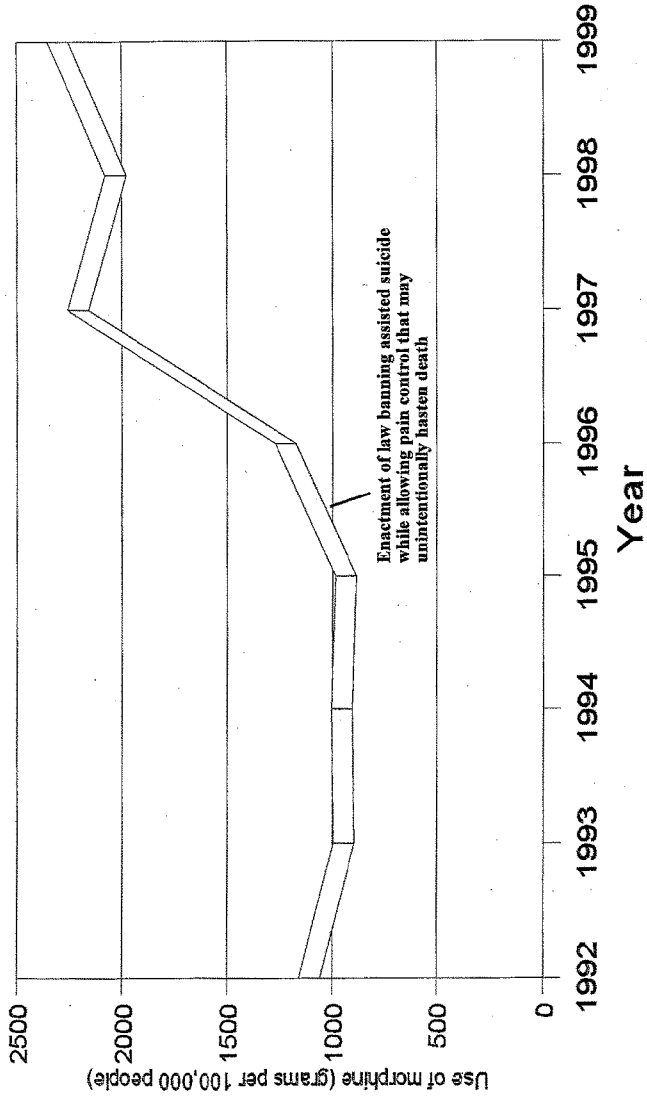

(Source of morphine data: Drug Enforcement Administration)

Use of Pain Control Drugs Rises When States Ban Assisted Suicide

VIRGINIA

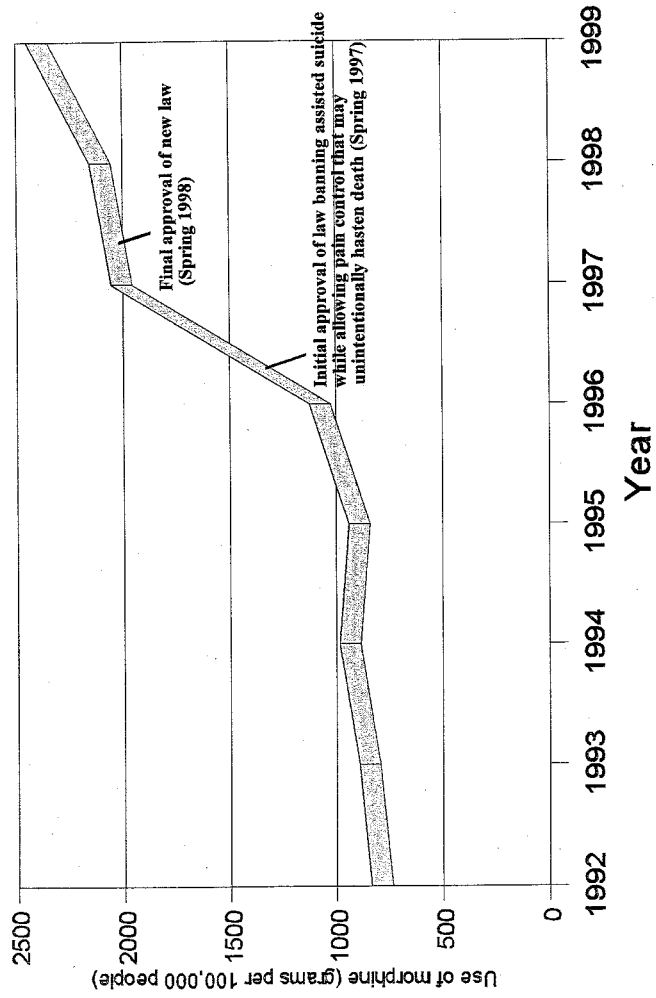

(Source of morphine data: Drug Enforcement Administration)

Use of Pain Control Drugs Rises When States Ban Assisted Suicide

TENNESSEE

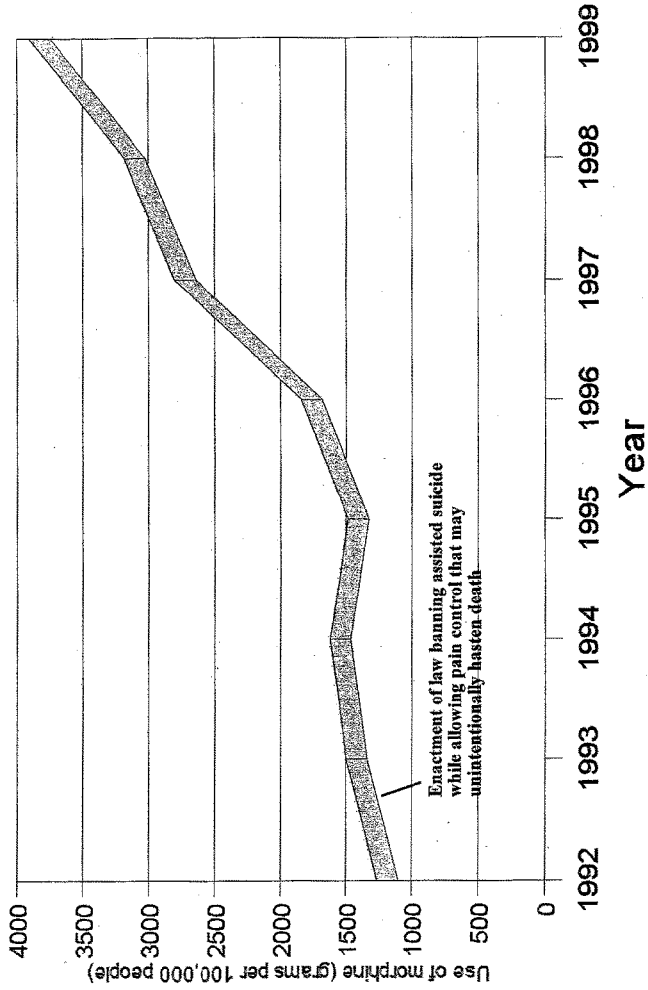

(Source of morphine data: Drug Enforcement Administration)

Use of Pain Control Drugs Rises When States Ban Assisted Suicide
LOUISIANA

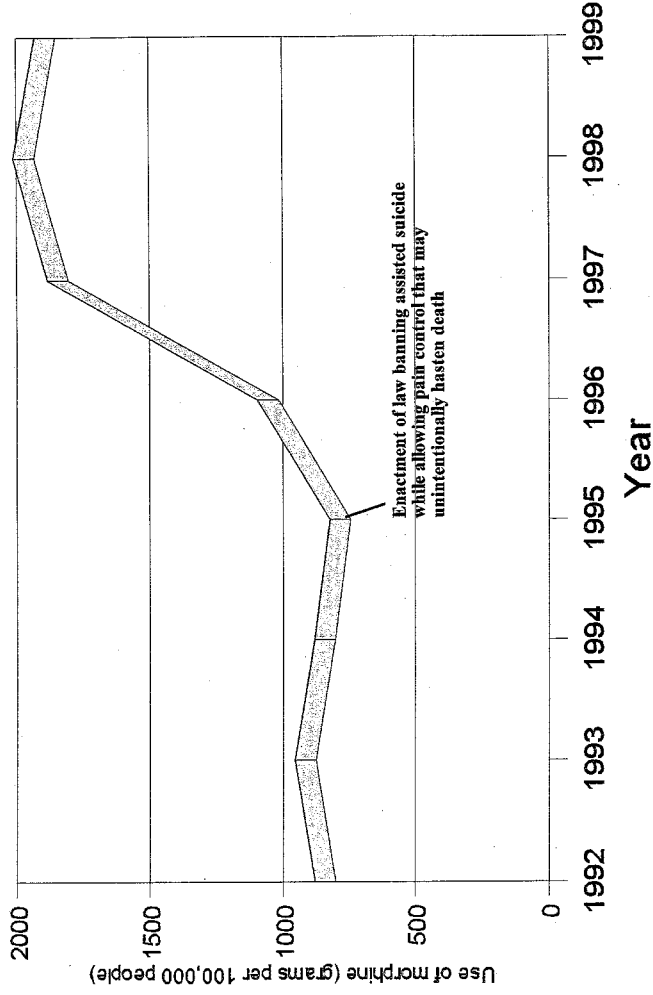

(Source of morphine data: Drug Enforcement Administration)

Use of Pain Control Drugs Rises When States Ban Assisted Suicide

RHODE ISLAND

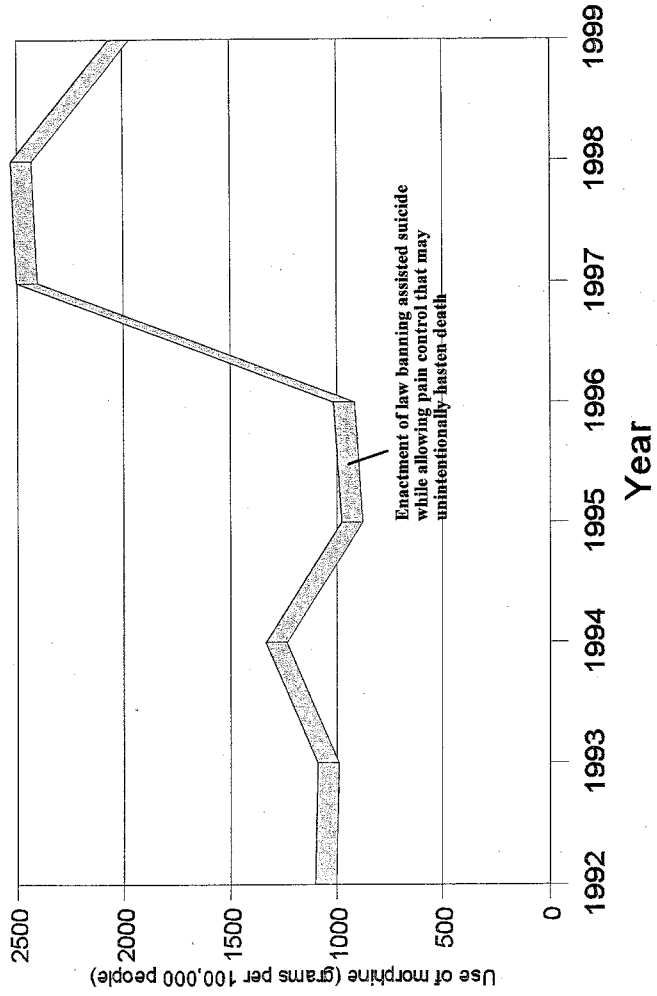

(Source of morphine data: Drug Enforcement Administration)

Use of Pain Control Drugs in Oregon

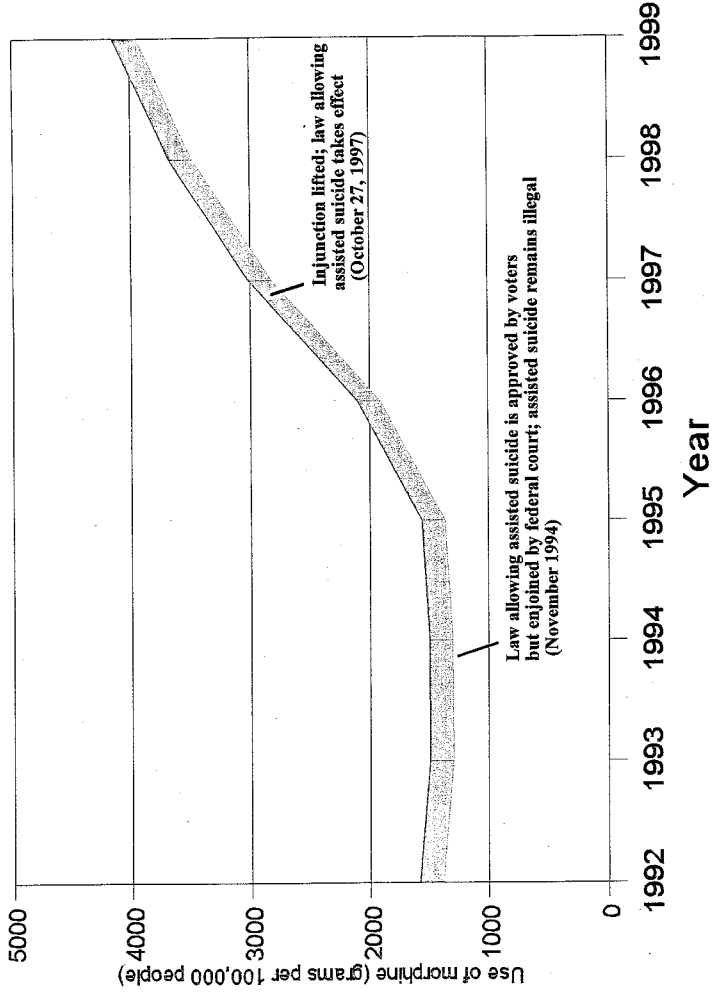

(Source of morphine data: Drug Enforcement Administration)

“Section 101 of H.R. 2260 amends section 303 of the Controlled Substances Act (‘CSA’), 21 U.S.C. § 823, to specify that the use of controlled substances to ‘alleviat[e] pain or discomfort in the usual course of professional practice’ is a ‘legitimate medical purpose’ under the CSA, 21 U.S.C. § 841, ‘even if the use of such a substance may increase the risk of death.’ Because a physician who acts with a ‘legitimate medical purpose’ is acting in compliance with the Act, H.R. 2260 creates a ‘safe harbor’ against administrative and criminal sanctions when controlled substances are used for palliative care.....The Department fully supports these measures. H.R. 2260 would eliminate any ambiguity about the legality of using controlled substances to alleviate the pain and suffering of the terminally ill by reducing any perceived threat of administrative and criminal sanctions in this context. The Department accordingly supports those portions of H.R. 2260 addressing palliative care.”

U.S. Department of Justice on the Pain Relief Promotion Act

The CHAIRMAN. Dr. Caplan, we will turn to you.

STATEMENT OF ARTHUR L. CAPLAN

Mr. CAPLAN. Thank you, Mr. Chairman. It is an honor to have the opportunity to address you and the committee on this subject. It seems as if it has become obligatory in the hearing to declare one's opposition to physician-assisted suicide. I am someone who is opposed. I understand that there are people of good will, as we heard from the Senators from Oregon who disagree about physician-assisted suicide, but I am no friend of legalization of physician-assisted suicide. I have tried to argue for many, many years now in numerous publications and opinion pieces, testimony to professional groups and legislative bodies that legalization is bad public policy, and I still believe it. I believe that legalization is not ethical in a nation that might inadvertently make PAS more of an expectation than an option.

To put the moral point more simply, a nation that has not guaranteed a right to healthcare from the doctor is morally in trouble in trying to make first a right to be aided in dying by the doctor. So if we cannot get into the system by dint of right, it seems to me morally problematic that we would be creating rights to exit from this earth at the hands of a doctor.

All that said, I am opposed to PRPA. If the chair will indulge me, I have a statement. I will enter it into the record. But I just wanted to talk a little bit about some of the reasons for my opposition to this legislation, and I will start it with a little story.

I was in a hospital a week ago doing what is sometimes called an ethics consultation on a case. It was a little hospital in Philadelphia. An individual was dying. She had gotten different types of treatment for her cancer and was receiving aggressive pain control, heavy use of narcotic drugs. She had had different treatments stopped, and she certainly was terminally ill and was going to die.

Her sister arrived from the West Coast well into the process of her dying and accused the doctor of killing her sister. She said, "You are killing her. I do not trust what you are doing with these drugs. I do not trust what you are doing with this treatment. I think you are trying to kill my sister." Her sister was certainly going to die and the sister who had come from afar was torn up with emotion about guilt for not having seen her for many years and her natural impulse was to be protective in that circumstance.

But the charge hit home. The doctor was afraid about what might happen with this kind of an accusation being levied, and that is what I was doing there, was to try and talk through the issue with this sister. And eventually, I am happy to report, we did succeed in explaining to her why it was that the treatment had shifted from aggressive care for the disease to palliation and support for her dying, and the sister understood that.

It took a long time, and in conversation later with the doctor, not a hospice specialist, not someone expert at care of the dying, just someone expert at the treatment of cancer, an oncologist, he said, "That scares me. I cannot stand that kind of publicity. It would damage my medical career to have those kinds of accusations levied against me, that I am being overly aggressive or actually killing my patients."

That is, in a nutshell, the source of my worry and concern about the PRPA. I understand what the issues are with respect to the battle over the Federal Government's role regarding controlled substances. Whether that is a useful lever to come after the Oregon action, I will leave to you and jurists and others.

All I can say is the movement toward the aggressive relief of pain is a fragile one. It has taken a long time to push medicine in this direction. Some in the hospice movement, some who are expert at the care of the dying are going quickly, but others move very slowly. I believe the majority of healthcare professionals are moving very slowly. It is a tentative, fragile movement towards saying, I will manage pain aggressively. We will not let the dying suffer. And putting into play the murky world of intent at times when emotions run high, when feelings run deep, as was true in this story I am recounting to you from Philadelphia, it seems to me that will be enough to put a chill, despite all the encouragement in the PRPA, to use pain medicine aggressively. The very idea that people might worry that they will be accused, that they will have fingers pointed, and that authorities may come simply to look may be enough to chill this nascent movement.

So I would argue that at the present time the correct course is not to try and use the Controlled Substance Act and Federal authority to try to undermine views about physician-assisted suicide. My belief is that this is a fragile movement toward aggressive treatment of pain. It should not be interrupted at the present time. I do not worry about the experts in dying who sit with me on this panel. I worry about those doctors who deal with it intermittently, rarely, in highly-charged climates, and what this legislation is going to tell them, I believe, is go slower, be cautious, look out for that DEA, worry about the allegation. And that, to me, is enough of a reason not to pass this legislation at the present time. Thank you.

The CHAIRMAN. Thank you, Dr. Caplan.

[The prepared statement of Mr. Caplan follows:]

PREPARED STATEMENT OF ARTHUR L. CAPLAN

I am very pleased at the opportunity to address this committee. I know that there are many people of good will who hold differing views about the Pain Relief Promotion Act. Often the opinion held about this proposed legislation is a function of where an individual stands with respect to the vexing question of physician assisted suicide. That is not so in my case.

I am no friend of the legalization of physician assisted suicide. I have argued in numerous publications, opinion pieces and in testimony to various professional groups and legislative bodies that legalization of PAS is bad public policy. I believe that legislation is not ethical in a nation that might inadvertently make PAS more of an expectation than an option. And I believe that PAS is simply not necessary when health care and medicine do their jobs and supply aggressive pain control and suffering relief to those with terminal illnesses.

Ironically, it is my belief, that aggressive pain control is the ethical route for medicine to take toward the dying that makes me wary and ultimately opposed to the Pain Relief Promotion Act. It is my opinion, based upon many years of studying and writing about the ethics of care at the end of life, that this legislation will do more harm than good.

My reasons for this position are: (1) the legislation risks inhibiting the aggressive treatment of pain; (2) decisions about pain control and the treatment of the dying should be kept as much as possible in the hands of and under the discretion of health care professionals, not legal authorities; and, that any attempt to control or prohibit the practice of physician assisted suicide should not be undertaken in the form of legislation that restricts, hinders or threatens the willingness of doctors and

other health care professionals to aggressively relieve the pain and suffering of the dying. The regulation or prohibition of the practice of PAS should be accomplished through explicit efforts addressed to this practice, not by indirection.

Why am I concerned about the chilling effect the proposed legislation might have on doctor's and administrator's willingness to insure that pain control is aggressive and thorough? It is well known from many previous studies that physicians cite legal concerns as one of the main reasons for their unwillingness to use narcotics and other agents to control pain aggressively. Physicians often exaggerate their risks of legal liability for end-of-life practices, even when the practices are clearly permitted by law. Doctors and nurses may not always fully understand what the law permits or does not, but when the issue requires an assessment of intent in an area as fraught with nuances and pitfalls as the end of life care then I believe that this legislation will scare many doctors and nurses and administrators into inaction in the face of pain.

The unfortunate reality is that physicians greatly overestimate the possibility of legal repercussions. When criminal prosecutions carry the possibility of sentences up to life imprisonment, as is the case with the Pain Relief Promotion Act (PRPA), it is not surprising that physicians may well be especially reluctant to take their chances with the law. My concern about the chilling effect of PRPA on palliative care is widely shared (Washington Post, February 2, 2000:A22).¹

My second reason for concern is that I see no need to introduce more legal oversight at the bedside of the dying. Studies consistently indicate that physicians are unduly influenced by regulatory considerations in their use of opioids and other drugs. For example, triplicate prescriptions laws have resulted in marked declines in drugs covered by the laws, with the substitution of less desirable drugs. If the goal of the PRPA is to encourage pain control it is hard to see how the introduction of more liability and greater prosecutorial authority will achieve this end. Medicine has finally been prodded into action and is trying hard to address the challenge of improving the experience of dying and the management of end of life care as can be seen in various medical publications such as the March 21 special issue of the *Annals of Internal Medicine* which I had the honor to co-edit.

Passage of the PRPA risks undermining this hard won victory. The opportunity which now exists to encourage doctors to move toward taking pain control seriously should not be jeopardized by the implicit threat that their actions will be held up to increased prosecutorial review.

When the care of patient involves stopping food and fluids, dialysis antibiotics, pressors and other life-sustaining agents, it is simply too complex to call to being to ask whether the treatment of pain and suffering that results in what will be a certain death involves intent to any degree. These decisions are hard enough without asking health care teams to question each others motives and intentions and attitudes when death of the patient is a certainty.

Lastly, I know that there are many who would say that the intent of this legislation is not to engage the subject of PAS but rather to encourage the morally responsible management of pain control. I would respectfully maintain that intent, as I said above, is difficult to ascertain. It is the case that some favor the enactment of legislation that would inhibit the practice of PAS in Oregon or any other state that moves to legalize this practice then it would seem to me the appropriate course of action is to address the legality of such decision head-on. Trying to ban or prohibit PAS by the regulation of the practice of aggressive pain control is both an oblique approach to a subject that demands a direct confrontation and imperils the welfare of the dying by threatening to hold their pain and suffering hostage in the name of banning of practice that has nothing to do with palliative care.

I would urge this committee to reflect deeply on what is likely to insure the best possible care for a dying relative or friend. It is adding layers of regulatory and prosecutorial intrusion into the clinical practice of end of life care or to let the practice of aggressive pain control remain primarily in the hands of those at the bedside? I firmly believe it is the latter that will serve the best interest of those who are terminally ill.

STATEMENT OF RABBI J. DAVID BLEICH

Rabbi BLEICH. Thank you very much, Mr. Chairman, members of the committee. I am deeply appreciative of this opportunity to appear before you to present the perspective of Jewish law and tradi-

¹Freer JP. Congress and the Pain Relief Promotion Act. *West J Med.* 2000; 172:5-6.

tion with regard to the provisions of the Pain Relief Promotion Act of 2000.

The salutary positive effects of this proposed legislation are certainly ones that Jewish tradition would support to the fullest extent. The provisions of the Act promote palliation of pain even when death as a result of use of that pain medication is possible and even plausible. That position is usually expressed as based upon the double effect theory. I will not presume upon your time to trace the history of the double effect theory and to trace its origins to sources in rabbinic law. Judaism accepts the double effect theory with a caveat that when the effect is inescapable, the inescapability of the unwanted and immoral effects imputes intent.

Jewish law posits other obligations with regard to palliation of pain even when the palliative measures are themselves hazardous and carry with them the danger of foreshortening life. It is an assumption of Jewish law, and I believe it to be an irrebuttable assumption of Jewish law, that pain is itself a cause of death and that particularly in the case of a terminal patient, the trauma and stress associated with pain can hasten the death of the otherwise terminal patient.

Prolongation of life is a value which is fundamental to Judaism. All life is of infinite value and every moment of human life is of infinite value. Judaism, in general—with some exceptions, of course—advocates the prolongation of life. Since Judaism regards pain as itself a danger, it regards the palliation of pain not only as permissible but as mandatory, and when that palliation is accompanied by hazards, it treats the hazards associated with the palliation in a manner no differently from that in which it treats hazards associated with any medical practice.

There is very little that a physician has in his black bag that does not pose a danger. Major surgery is very dangerous for everyone, and more dangerous to the weak, the infirm, and those suffering from debilitating illnesses. In any case in which a hazardous protocol is advocated, a balancing act must be entered into. Risk-benefit ratios have to be established. When the risks are prudent, then by all means the procedure should be instituted, and the same is true with regard to medication that may have the effect of hastening death, including palliative care medication.

For the first time, the Pain Relief Promotion Act enshrines in statute that notion, the notion that medications may be used to palliate pain, even if there is the distinct possibility that they will hasten death, so long as there is no intent of hastening death. And the presumption in every case is wisely enshrined in the statute in favor of the physician. The physician need not offer his motives as an affirmative defense. Quite on the contrary, his intent to cause death must be demonstrated before the sanctions of the statute can be invoked against him.

The Pain Relief Promotion Act will not have the effect of reducing the incidence of physician-assisted suicide. To be quite candid, I would not at all be distressed if it did. But in point of fact, I am not an optimist to believe that it will. What it will accomplish is to remove the imprimatur of the Federal Government from that process. The Assisted Suicide Funding Retribution Act of 1997 recognized that the taxpayers of all the States of this country should

not be implicated through the use of their tax dollars in assisting suicide. This Act, recognizing that these drugs can be used only with regular licensure, recognizes that every citizen is implicated in the use of such drugs for purposes of hastening death.

Hastening of death has been recognized since the 16th century in *Hales v. Petit* as a breach of the King's peace. In a usage that to us in the 21st century seems quaint and archaic, in that court decision, the term "king" is spelled with a capital "K". It is the reference, I would believe, to the King of kings, and assistance in suicide, the taking of any human life, is a breach of the peace of the King of kings.

The legal system has a way of incorporating Judeo-Christian values in secular language. The firm opposition of the common law legal tradition to suicide and assisted suicide is firmly rooted in those values. I will not presume upon your time. I am already over-time.

Let me conclude with a rabbinic aphorism. Man has no choice with regard to coming into this world, with regard to his life, or with regard to his death. But nowhere is a similar aphorism with regard to the fact that man has no power or control over his pain, suffering, and misery. While man does not have the right to take his own life in his hands, he does have the right to take pain into his hands and control, and it is precisely those dual moral principles which are expressed and enforced by the Pain Relief Promotion Act. I thank you.

The CHAIRMAN. Thank you, Rabbi.

[The prepared statement of Rabbi Bleich follows:]

PREPARED STATEMENT OF RABBI J. DAVID BLEICH

My name is J. David Bleich. I am a Professor of Law at the Benjamin Cardozo School of Law, Professor of Talmud and Director of the graduate program in Jurisprudence and Family Law at the Rabbi Issac Elchanan Theological Seminary, as well as Herbert and Florence Tenzer Professor of Jewish Law and Ethics at Yeshiva University. I have been requested by the Union of Orthodox Jewish Congregations of America to testify before the Senate Committee on the Judiciary regarding the proposed Pain Relief Promotion Act.

Permit me to make two points at the outset. Judaism places the highest importance on palliation of pain, particularly in the case of terminal patients. Jewish law regards pain suffered by terminal patients as life-threatening, in the sense that such pain has the potential for compromising the brief longevity anticipated for the terminal patient. I believe this teaching to be grounded upon physiological realia. I also believe that this principle represents an irrebuttable presumption of Jewish law, not subject to empirical refutation. Such presumptions are recognized in virtually every legal system. A good example is the common law presumption that a husband is the father of the child of his lawfully wedded wife so long as he was physically within the boundaries of the five seas of England during the requisite time period, with the result that no person can be heard by a court of law to challenge that presumption.

In light of its presumption regarding the life-threatening nature of pain, Judaism permits, and indeed mandates, violation of religious strictures such as Sabbath restrictions and the like in order to alleviate the pain of patients in extremis. For precisely the same reason, Jewish law endorses use of pain relieving drugs even in situations in which administration of the drug carries with it a statistical danger of foreshortening life. That risk is treated no differently from the risk associated with any other hazardous procedure which, when successful, is designed to prolong life.

It should also be noted that, for similar reasons, Jewish law sanctions violation of religious law in order to assuage the otherwise uncontrollable crying of a child, as in the case of an infant who becomes traumatized upon locking himself in a room. There is also substantial rabbinic authority sanctioning acceptance of potentially

hazardous procedures for elimination of chronic pain even in the absence of a terminal condition.

Accordingly, Jewish law and tradition would enthusiastically endorse the provisions of H.R. 2260 designed to encourage more extensive and more effective palliation of pain.

Let me preface my second point by saying that at times I find myself suffering from intellectual schizophrenia. There are occasions on which I do not know whether to don the jurist's wig or the rabbinic skullcap; occasions on which I do not know whether I should respond as a Professor of Law or an expositor of Halakhah (Jewish law). The responses of those two personae are not always univocal. In addressing the question of assisted suicide, however, I experience no conflict.

Judaism teaches that suicide is an offense against the Deity who is the Author of life. Common law regards suicide as an offense against the temporal sovereign. The interest of the State in preventing suicide was first articulated in the sixteenth century British case, *Hales v. Petit*. In *Hales* the court enumerated a number of diverse objections to suicide. One crucial consideration is that suicide is a crime "[a]gainst the King in that thereby he has lost a subject . . . one of his mystical members," Suicide may be prevented—and punished—by the King because it constitutes interference with his rights as monarch. In his *Commentaries*, Blackstone writes that "[T]he suicide is guilty of a double offense; one spiritual in evading the prerogative of the Almighty, and rushing into his immediate presence uncalled for; the other temporal, against the king, who hath an interest in the preservation of all his subjects . . ."

The common law notion of preservation of life as a monarchical prerogative has been transformed in American legal theory into an inherent function of government. Thus Thomas Jefferson wrote, "[T]he care of human life and happiness, and not their destruction, is the first and only legitimate object of good government." In the United States, the State interest in prolongation of life has been tempered by the decision of the New Jersey Supreme Court in *In re Quinlan*, which expressed the notion that the State's interest weakens and the individual's right to privacy grows "as the degree of bodily invasion increases and the prognosis dims."

However, *Hales* identifies a further State interest in prohibiting suicide, in declaring that suicide is an offense against the King in that "the King who has the government of the people [takes] care that no evil example be given them." Killing invites imitation; therefore, self-destruction serves as an "evil example" encouraging emulation by other susceptible members of society. Suicide "infringe[s] upon the King's peace" because a suicide is not an isolated individual act. The harm is not really to the king as an individual but constitutes an offense against society because of potential harm to others. If openly permitted, suicide diminishes commitment to the preservation of life and compromises the State's interest in preserving respect for life which constitute the fundamental underpinning of the social fabric.

Our legal system, in balancing the interests of the individual against those of the State, cogently distinguishes between refusal or withdrawal of life sustaining measures and overt, active termination of life. Medicine is not merely an art or a science; it is a calling and vocation. Judaism teaches that physicians practicing the healing arts function as agents of the Divine healer. Physicians are charged with preserving and prolonging life; in taking the Hippocratic oath they solemnly pledge themselves to do so. Physician-assisted suicide—or, as I have called it, "thanatology," the science of death—is antithetical to the values and mores of the healing arts and dare not be allowed to emerge as a new area of medical specialization. Availability of physician-assisted suicide represents a Copernican revolution in the physician-patient relationship. Physicians would perforce become agents of death rather than of life, purveyors of despair rather than of hope. Legalization of physician-assisted suicide would pose the greatest threat to the poorest and most vulnerable of our patients, those without the means and the stamina to withstand pressure, both subtle and not so subtle, for acceptance of termination of life. For those reasons—and for others as well—the New York State Task Force on Life and the Law on which I serve was unanimous in its recommendation against legalization of physician-assisted suicide.

It is the issue of assisted suicide—and only the issue of assisted suicide—that is posed by H.R. 2260. This Act permits and indeed encourages palliative care in a manner heretofore never enshrined in statute. The bill pays full deference to the physician's judgment with regard to dosage and titration, so long as there is no demonstrable intent to cause death. The bill establishes no new investigatory or regulatory process; it mandates no expansion of Federal authority. In no way does it hamper the practice of medicine or interfere with the physician's exercise of professional judgment. Its effect is to encourage meaningful pain management and to provide full protection to medical practitioners who provide palliative care.

The bill recognizes that, at present, physicians are woefully undertrained in pain management and provides funding to expand educational programs in that area. Such training programs should certainly stress that a physician engaged in bona fide pain palliation need have no fear of adverse legal consequences.

The effect of H.R. 2260 is solely to remove the Federal imprimatur for assisted suicide. Controlled substances may be dispensed only with a Federal license and only for purposes approved by the Federal government. Use of controlled substances in physician-assisted suicide implies that such action is not inimical to the mores of our society as expressed by the Federal government. Federal licensure implicates the citizens of all States in an act that is morally repugnant to the majority of our populace and offensive to the traditions of this country. Forbidding such use will not prevent assisted suicide in a jurisdiction in which it is not otherwise contrary to law; rather, it loudly and unequivocally affirms the Federal government's commitment to the moral values and common law principles enunciated in *Hales*.

The CHAIRMAN. Dr. Foley, we will turn to you.

STATEMENT OF KATHLEEN FOLEY, M.D.

Dr. FOLEY. I wish to express my appreciation for the opportunity to speak before this hearing and to express my concerns about the proposed legislation and my opposition to it.

For the last 25 years, I have directed a program in clinical pain management and research at Memorial Sloan-Kettering Cancer Center. I have chaired two World Health Organization cancer unit expert advisory panels that have developed guidelines for the management of cancer pain and for initiatives in palliative care.

Americans deserve humane, compassionate care at the end of life. National initiatives in pain research and education are urgently needed. I thank the authors of the PRPA for attempting to address some of the barriers to an inadequate pain management and to palliative care. Yet, I remain concerned that the current Act sends the wrong message to drug regulators, physicians, and patients about the medical use of controlled substances.

As proposed, the bill provides insufficient funding to have any real impact on pain and palliative care education and training. It does not begin to address the seven recommendations to improve end-of-life care that were made by the Institute of Medicine of the National Academy of Sciences in its report entitled, "Approaching Death," and I have included these in my transcript.

And last, it will have no impact on changing the flawed monitoring process of the Oregon Death With Dignity Act. It has prevented a full, open, and nonpartisan evaluation of assisted suicide practices in Oregon.

The CHAIRMAN. Dr. Foley, if I could just interrupt you for a second, I have to go meet with the majority and minority leaders, so I am asking Senator Sessions to continue chairing this.

Senator Sessions, I have also allowed a period of time for Senator Wyden to ask questions this morning as a guest of the committee.

Senator WYDEN. Before you leave, Mr. Chairman, I just want to express my thanks to you.

The CHAIRMAN. Sorry to interrupt you. I apologize.

Senator SESSIONS [presiding]. Excuse me, Dr. Foley. Please go ahead.

Dr. FOLEY. The wrong message. Pain and palliative care experts have defined clear distinctions between pain management and palliative care and physician-assisted suicide. Yet, it has been the advocates for physician-assisted suicide who have used the arguments

that opioids such as morphine kill and then have tried to relate these practices.

Yet, there is a preponderance of evidence that demonstrates that the proper use of opioids, narcotics like morphine, in patients with chronic pain, as well as in patients at the end of life, does not hasten their death. There is accumulating data to suggest that, in fact, the proper use of opioids may, in fact, prolong their lives. Studies by Dr. Brescia at Calvary Hospital in New York City show that there is no correlation between the dose of opioid that a patient receives in the last weeks of life and the timing of their death. Studies of dying patients who are being withdrawn from respiratory support demonstrate that those patients who received morphine received longer than those who did not receive morphine. Studies recently published by the British hospices show no difference in the time to death between those patients who were sedated to control their symptoms as compared to those who were not sedated.

And finally, the doses of opioids that are often used to treat patients at the end of life are highly variable. The great majority of dying patients are receiving doses in a range equivalent to what you and I might receive as part of post-operative pain management. These doses are safe and effective.

In short, the underpinnings of this legislation are not based on scientific evidence. It would be unwise to institutionalize the myth into law that pain medications hasten death.

In the last 25 years, through the development of scientific guidelines and a natural experiment of treating cancer patients and non-cancer pain patients with analgesic drugs, specifically opioids like morphine, we have shown that patients can take these drugs for months to years and continue to obtain pain relief. We have demonstrated that they do not develop respiratory depression with increasing doses because tolerance develops to the respiratory depressant side effects. Increasing the availability of these drugs for medical purposes is not associated with an increase in drug diversion.

Yet, lack of knowledge about pain assessment and treatment, lack of knowledge about the use of these drugs and the control of symptoms in the dying, coupled with a strong regulatory environment, have led to significant under-treatment and underassessment of patients with pain, particularly at the end of life. Working with Mr. David Joranson and Dr. June Dahl at the University of Wisconsin and many others, we have advocated for a balanced drug policy to assure that opioid analgesics will be available for legitimate medical purposes. We have also worked through the World Health Organization with the International Narcotics Control Board, who have strongly urged its member countries, like the United States, to place a high level of importance on the medical use of opioids for the treatment of patients with pain.

The PRPA Act, by expanding the authority of the Controlled Substance Act, will disturb the balance that we have all in the pain community worked so hard to create. Physician surveys in my own State by the New York State Department of Health have shown that a strict regulatory environment negatively impacts on physicians' prescribing practices. It leads them to intentionally under-treat patients with pain because of concern of regulatory oversight.

In the last 5 years, there has been increased attention to inadequate care of patients at the end of life and to the inadequacy of pain management in patients throughout the course of their medical illness. Five studies have consistently shown that we have a health care system that prevents patients from obtaining appropriate pain assessment and treatment and appropriate palliative care. These include studies that show that only 37 percent of children with cancer in the last days of life received adequate treatment for their pain, that less than 25 percent of elderly patients in nursing homes received any approaches for their pain management.

Minorities are particularly impacted by the under-treatment of pain and lack of access to palliative care. Studies show, in fact, that this under-treatment occurs in the post-operative setting, in trauma, in emergency rooms, and in cancer pain. And complicating this under-treatment is a lack of availability of opioid drugs in the pharmacies that serve these minority neighborhoods. This lack of access leads to needless suffering.

I am emphasizing these studies only to suggest that this current Act will do little to alter the current system of care that impedes particularly vulnerable populations, such as children, the elderly, and minorities, from receiving adequate pain management and palliative care.

On the issue of insufficient funding, both the PRPA and the Hatch amendments establish a program for pain and palliative care research and quality within the Agency for Healthcare Research and Quality. The problem with this is that, as much as it is a laudable endeavor, we have in place sufficient guidelines for pain management. They have already been issued by the agency. The problem is not a lack of guidelines or lack of information but an inability to implement the information we currently have into practice.

At the present time, the PRPA authorizes \$5 million to the Health Resource and Service Administration grants program. This is a small amount of money to create an enduring change for the 50 million Americans who suffer daily with chronic pain and an equal number who have episodes of acute pain and the 2.4 million Americans who die each year, 70 percent of whom report significant pain.

It does not include funding for demonstration projects that put into practice pain management and palliative care programs. It does not support role model physicians in facilities around the country. What we need in every community hospital is an expert physician and nurse who can serve both as a role model and resource to their peers and patients about appropriate pain management and palliative care.

Senator SESSIONS. Dr. Foley, if you could wrap up, and we can make your whole remarks part of the record, though.

Dr. FOLEY. Lastly, the Hatch amendment has suggested the creation of a decade of pain control and research beginning in the year 2001. I want to thank Senator Hatch for his advocacy for pain patients in the past, but to create an initiative without an implementation process and an appropriate funding stream is an empty promise to patients suffering with pain.

Senator SESSIONS. Thank you very much.
[The prepared statement of Dr. Foley follows:]

PREPARED STATEMENT OF KATHLEEN M. FOLEY, M.D.

Mr. Chairman and Committee: I am Dr. Kathleen M. Foley, Attending Neurologist, in the Pain & Palliative Care Service at Memorial Sloan-Kettering Cancer Center and Professor of Neurology, Neuroscience and Clinical Pharmacology at the Cornell University Medical College.

I wish to express my appreciation for the opportunity to speak before this Senate Hearing and to express my concerns about the proposed legislation and my opposition to it.

For the last 25 years, I have directed a program in clinical pain management and research at Memorial Sloan-Kettering Cancer Center. I have chaired two World Health Organization Cancer Unit Expert Advisory Panels that have developed guidelines for the management of cancer pain and for initiatives in palliative care.

Americans deserve humane, compassionate care at the end of life. National initiatives in pain research and education are urgently needed. I thank the authors of the PRPA for attempting to address some of the barriers to inadequate pain management and palliative care.

Yet, I remain concerned that the Pain Relief Promotion Act sends the wrong message to drug regulators, physicians and patients about the medical use of controlled substances. As proposed, the Bill provides insufficient funding to have any "real" impact on pain and palliative care education and training. It does not begin to address the seven recommendations to improve end of life care made by the Institute of Medicine of the National Academy of Sciences in its report entitled "Approaching Death." (See attached) Lastly, it will have no impact on changing the flawed monitoring process of the Oregon Death with Dignity Act that has prevented a full, open and non-partisan evaluation of assisted suicide practices in Oregon.

THE WRONG MESSAGE

Pain and palliative care experts have defined clear distinctions between pain management and palliative care, and physician assisted suicide. Yet, it has been the advocates for physician assisted suicide who have used the argument that opioids, such as morphine, kill and to try to relate these practices. Yet, there is a preponderance of evidence that demonstrates that the proper use of opioids in patients with chronic pain, as well as in patients at the end of life, does not hasten their death. There is accumulating data to suggest that the proper use of opioids may in fact prolong their lives.

Studies by Dr. Brescia at Calvary Hospital in New York City show that there is no correlation between the dose of opioids a patient receives in the last weeks of life and the timing of their death. Studies of dying patients who were being withdrawn from respiratory support demonstrate that those patients who received morphine lived longer than those who did not receive morphine. Studies recently published from a series of British hospices show no difference in the time to death between those patients who were sedated to control their symptoms as compared to those patients who were not sedated. Finally, the doses of opioids that are often used to treat patients at the end of life are highly variable. The great majority of dying patients are receiving doses in a range equivalent to what you or I might receive as part of postoperative pain management and these doses are safe and effective. In short, the underpinnings of this legislation are not based on scientific evidence. It would be unwise to institutionalize the myth into law—that pain medications hasten death.

In the last 25 years through the development of scientific guidelines and the natural experiment of treating cancer pain patients and non-cancer pain patients with analgesic drugs, specifically opioids, we have shown that patients can take opioid drugs for months to years and continue to obtain pain relief. We have demonstrated that they do not develop respiratory depression with increasing doses because tolerance occurs to the respiratory depressant side effects. Increasing the availability of these drugs for medical purposes is not associated with an increase in diversion to an illegal market. Yet, lack of knowledge about pain assessment and treatment, the use of analgesic drugs, and the control of symptoms in the dying coupled with a strong regulatory environment have led to the significant undertreatment and underassessment of patients with pain, particularly at the end of life.

Working with Mr. David Joranson and Dr. June Dahl at the University of Wisconsin and with many others, we have advocated for a balanced drug policy to assure that opioid analgesics will be available for legitimate medical purposes. We

have also worked with the International Narcotics Control Board who has strongly urged its member countries, including the U.S., to place a high level of importance on the medical use of opioids for the treatment of patients with pain.

The PRPA, by expanding the authority of the Controlled Substance Act, will disturb the balance that we have worked so hard to create. Physician surveys by the New York State Department of Health have shown that a strict regulatory environment negatively impacts physician prescribing practices and leads them to intentionally undertreat patients with pain because of concerns of regulatory oversight.

In the last five years, there has been increased attention to the inadequate care of patients at the end of life, and to the inadequacy of pain management in patients throughout the course of their medical illness. Five studies have consistently shown that we have a health care system that prevents patients from obtaining appropriate pain assessment and treatment and appropriate palliative care. These studies show that 37% of children with cancer in the last days of life were inadequately treated for their pain by parent report. Recent data from nursing home surveys demonstrate that 40% of elderly cancer patients have pain but less than 25% are receiving any form of analgesic drug therapy. Minorities are particularly impacted by the undertreatment of pain and lack of access to palliative care. Studies show that minorities are undertreated for their postoperative, traumatic, and cancer pain. Complicating this undertreatment is the lack of availability of opioid drugs in pharmacies that serve minority neighborhoods. This lack of access leads to needless suffering. Finally, the SUPPORT study of 10,000 seriously ill hospitalized patients demonstrated that 50% have significant pain in the last days of life.

I am emphasizing these studies only to suggest that the current Pain Relief Promotion Act will do little to alter the current system of care that impedes particularly vulnerable populations such as children, the elderly, and minorities from receiving adequate pain management and palliative care.

INSUFFICIENT FUNDING

The PRPA and the Hatch amendments establish a program for pain and palliative care research and quality within the Agency for Healthcare Research and Quality “to develop and advance scientific understanding of palliative care and to collect, disseminate and make available information on pain management, especially for the terminally ill, professionals and the general public.” This is clearly a laudable endeavor. However, we have in place sufficient guidelines for pain management that have already been issued by the Agency for both acute pain and chronic cancer pain. The problem is not a lack of guidelines, or a lack of information but an inability to implement the information that we currently have into practice. This requires not only the training of health care professionals and the public but the provision of payment to physicians for their services and payment for the costly prescription drugs.

The PRPA authorizes \$5 million dollars for a Health Resources and Services Administration grants program. This is a small amount of money to create an enduring change for the 50 million Americans who suffer with chronic pain, and an equal number who have episodes of acute pain, and the 2.4 million Americans who die each year.

What the PRPA does not include is funding for demonstration projects that will put into practice pain management and palliative care programs. For example, demonstration projects that will evaluate how to bridge the gap between palliative care and hospice care programs; demonstration projects that will support role models within institutions such as the VA and PDIA Faculty Scholars Program.

What is needed in every community hospital is an expert physician and nurse who can serve both as role models and resources to their peers and to patients about appropriate pain management and palliative care.

Lastly, the Hatch amendment has suggested the creation of “The Decade of Pain Control and Research” beginning in the year 2001. I want to thank Senator Hatch for his advocacy for pain patients, but to create an initiative without an implementation process and an appropriate funding stream is an empty promise to patients suffering with pain.

There is currently no center on pain research at NIH. There is not even an office to coordinate pain research initiatives. There is no external advisory board to provide input and oversight to pain initiatives. The need for a coordinated, focussed effort with strong leadership and an external advisory board has been strongly advocated by the pain community but has not been implemented at a governmental level and this Bill fails to respond to this need.

In short, this proposed legislation does not adequately respond to the Institute of Medicine recommendations to improve end of life care and falls significantly short of institutionalizing national programs in pain relief and palliative care.

THE OREGON SITUATION

If this Committee wishes to address its concerns about physician assisted suicide in Oregon, it should recognize that it is barbiturates, not opioids, that are currently being prescribed to aid patients in death. Barbiturates are not used in pain management because they are ineffective as analgesics.

The current environment in Oregon has suppressed open discussion and limited the ability to evaluate whether Oregonians do, in fact, receive quality end-of-life care. The current monitoring process is flawed because it only interviews physicians who have aided patients in death, thereby devaluing the medical decisions of physicians who have refused to assist patients in suicide.

In closing, as you consider this legislation, it is important to recognize that proposals that are well meaning and well intentioned should have as their first priority the goal to improve pain management and palliative care for those who so desperately need it.

INSTITUTE OF MEDICINE RECOMMENDATIONS ON THE CARE OF PATIENTS AT THE END OF LIFE

From: Approaching Death

Recommendation 1: People with advanced, potentially fatal illnesses and those close to them should be able to expect and receive reliable, skillful, and supportive care.

Recommendation 2: Physicians, nurses, social workers, and other health professionals must commit themselves to improving care for dying patients and to using existing knowledge effectively to prevent and relieve pain and other symptoms.

Recommendation 3: Because many problems in care stem from system problems, policy-makers, consumer groups, and purchasers of health care should work with health care practitioners, organizations, and researchers to

Strengthen methods for measuring the quality of life and other outcomes of care for dying patients and those close to them;

Develop better tools and strategies for improving the quality of care and holding health care organizations accountable for care at the end-of-life;

Revise mechanisms for financing care so that they encourage rather than impede good end-of-life care and sustain rather than frustrate coordinated systems of excellent care; and

Reform drug prescription laws, burdensome regulations, and state medical board policies and practices that impede effective use of opioids to relieve pain and suffering.

Recommendation 4. Educators and other health professionals should initiate changes in undergraduate, graduate, and continuing education to ensure that practitioners have relevant attitudes, knowledge, and skills to care well for dying patients.

Recommendation 5. Palliative care should become, it not a medical specialty, at least a defined area of expertise, education and research.

Recommendation 6. The nation's research establishment should define and implement priorities for strengthening the knowledge base for end-of-life care.

Recommendation 7. A continuing public discussion is essential to develop a better understanding of the modern experience of dying, the options available to patients and families, and the obligations of communities to those approaching death.

REFERENCES

Bernabei R, Gambassi G, Lapane K, et al Management of pain in the elderly patients Cancer. JAMA. 1999;281:136.

Breitbart W, MacDonald MV, Rosenfeld B, et al. Pain in ambulatory AIDS patients. I. Pain characteristics and medical correlates. Pain. 1996;68:315-21.

Brescia FJ, Portenoy RK, Ryan M, Drasnoff L, Gray G. Pain, opioid use and survival in hospitalized patients with advanced cancer. J Clin Oncology. 1992;10:149-155.

Cavanaugh TA. The ethics of death-hastening or death causing palliative analgesic administration to the terminally ill. JPSM. 1996;12:248-254.

Chaters S. Terminal sedation. 11th International Congress on Care of the Terminally Ill, Montreal. September 10, 1996.

- Cleeland CS, Gonin R, Hatfield AK, et al. Pain and its treatment in outpatients with metastatic cancer. *N Engl J Med*. 1994;330:592-6.
- Cohen FL. Postsurgical pain relief patients' status and nurses' medication choices. *Pain*. 1980;9:265-74.
- Emanuel AJ, Fairclough DL, Slutsman J, Emanuel L. Understanding economic and other burdens of terminal illness: the experience of patients and their caregivers. *Ann. Int. Med*. 2000;132(6):452-459.
- Foley KM, Hendin H. The Oregon Report. *Don't Ask Don't Tell*. 1999; 29 (3):37-42.
- Foley KM: Medical Issues Related to Physician-Assisted Suicide. Testimony, House Judiciary Subcommittee on the Constitution, Hearing on Physician-Assisted Suicide. April 29, 1996.
- Foley KM: Competent care for the dying instead of physician-assisted suicide. *NEJM* 1997; 336(1):54-58.
- Foley KM. The relationship of pain and symptom management to patient requests for physician-assisted suicide. *JPSM*. 1991;6:289-297.
- Freeman HP, Payne RP. Racial injustice in health care. *NEJM*. 2000;342(14):1045-1047.
- Ganzini L, Nelson HD, Schmidt TA, Kraemer DF, Delorik MA, Lee MA. Physicians' experiences with the Oregon Death with Dignity Act. *NEJM*. 2000;342(8):557-63.
- Institute of Medicine. Recommendations for Care at the End of Life. *Approaching Death*. Field MJ, Cassel CK. (eds). National Academy Press, Washington, DC. 1997.
- Jacox A, Carr DB, Payne R, et al. Management of cancer pain. Clinical practice guideline No. 9. Rockville, MD: Agency for Health Care Policy and Research. 1994:257. (AHCPR public no. 94-0592).
- Joranson D. U.S. Senate Hearing on Pain Management and Improving End of Life Care. October 13, 1999. (See University of Wisconsin Pain & Policy Studies Group.
- Joranson DE, Ryan KM, Gibson AM, Dahl JL. Trends in medical use and abuse of opioid analgesics. *JMA*. 2000;283(13):1710-4.
- Morrison SR, Wallenstein S, Natale DK, Senzel RS, Huang LL. "We don't carry that"—Failure of pharmacies in predominantly nonwhite neighborhoods to stock opioid analgesics. *NEJM*. 2000;342(14):1023-26.
- Mount B. Morphine drips, terminal sedation and slow euthanasia definitions and facts, not anecdotes. *J. Pall. Care*. 1996;12:31-37.
- Oates JD, Snowdon SL, Japson DW. Failure of pain relief after surgery: attitudes of ward staff and patients to postoperative analgesia. *Anesthesia*. 1994;49:755-8.
- Portenoy RK. Morphine infusions at the end of life. The pitfalls in reasoning from anecdote. *J Pall. Care*. 1996;12:44-46.
- Solomon M, O'Donnell L, Jennings B, et al. Decisions near the end of life: professional views of life-sustaining treatments. *American J. Public Health*. 1993;83:14-21.
- The New York State Public Health Council. Breaking down the barriers to effective pain management. Recommendations to improve the assessment and treatment of pain in New York State. Report to the Commissioner of Health Barbara A. DeBuono, M.D., M.P.H. January, 1998.
- The SUPPORT Principal Investigators. A controlled trial to improve care for seriously ill hospitalized patients the Study to Understand Prognoses and Preferences for Outcomes and Risks of Treatments (SUPPORT). *JAMA*. 1996;275:1232.
- Todd KH, Samaroo N, Hoffman JR. Ethnicity as a risk factor for inadequate emergency department analgesia. *JAMA* 993;269:1537-9.
- Von Roenn JH, Cleeland CS, Gonin R, Hatfield AK, Pandya KJ. Physician attitudes an practice in cancer pain management: a survey from the Eastern Cooperative Oncology Group. *Ann Intern Med*. 1993;119:121-6.
- Wilson WC, Smedira NG, Fink C, McDowell JA, Luce JM. Ordering and administration of sedatives and analgesics during the withholding and withdrawal of life support from critically ill patients. *JAMA* 1992;267;267:949-953.
- World Health Organization. Cancer pain relief and palliative care. World Health Organization. Geneva, 1990.

Senator SESSIONS. Dr. Hunter.

STATEMENT OF WALTER R. HUNTER, M.D.

Dr. HUNTER. Mr. Sessions, members of the committee, ladies and gentlemen, I am a full-time hospice physician with VistaCare Hospice, the second largest provider of hospice services in the United States. Nothing in this bill will change what I do daily in my work

as a hospice physician and nothing in this bill will diminish our work at VistaCare to aggressively and adequately treat pain.

You have heard many of the concerns expressed about this legislation as it originally stood. There are amendments before you that I think strengthen this bill and that I wholeheartedly support. I think it is a timely, necessary, and explicit clarification of the existing Controlled Substance Act for the reasons that have been already enumerated.

Currently, if I were to practice in 49 States, I would be subject to penalties for committing assisted suicide euthanasia. I would not be in Oregon based on an erroneous interpretation, I believe, by Attorney General Reno. So I think this bill does clarify existing CSA law.

I think that it is important to understand that in our clinical practice, there are times where the edge can seem to be very, very tight between intention and clinical practice, but I do believe that people that understand the principle of double effect, that understand how to use these medications, can be very clear in their intent, in their documentation. I do not believe that physicians need worry. And, in fact, I welcome the opportunity to have codification of the ethical principle of double effect.

This bill establishes that the United States Government stands firm in its commitment to ensure that patients receive the very best there is available in palliative care, but that the deliberate killing of those patients is neither endorsed nor encouraged by the United States Government. It is not unreasonable for the Controlled Substance Act to prohibit physician-assisted suicide or euthanasia as a condition for maintaining a DEA license. All licenses carry certain privileges and certain restrictions. It is disingenuous to believe a DEA license should have no restraints.

In addition to all of these benefits, this legislation does put end-of-life care, pain and symptom management, and the care of our citizens in the spotlight at the center of the stage. While it certainly is not the final word in a proactive response to the needs of our aging population and dying patients, it is an important start. As we study our progress in further developing hospice, palliative care, and pain treatment for our citizenry, Congress will be called upon again to recommit itself in principle and practice to ensuring comfort for all people who face serious or terminal illness. This legislation is, I believe, a giant step toward that commitment.

As a physician, I am ashamed to admit that the vast majority of our nation's medical schools and residency programs have simply failed to make medical ethics, pain and symptom management priorities in their curricula. This knowledge, however, is absolutely essential for physicians to properly provide excellent care for patients. Physicians can and must learn and understand thoroughly the principle of double effect and how that principle is incorporated into the clinical practice of palliative medicine and the intent of this legislation.

This legislation does provide for much needed education in the professional community. We at VistaCare applaud this bill for its commitment of monies for the advancement of understanding of palliative care and for the education of health care professionals in the principles and practice of palliative care. This commitment of

time and money to these educational efforts will send a very clear message that the U.S. Congress has taken up the cause of providing competent, compassionate, and comprehensive palliative care for our citizens who face life-threatening illness. This is an extremely important action both in concrete and symbolic terms. I extend to the sponsors of this bill my deepest gratitude for such a commitment.

Passage of this bill will send a clear message that the care of many of our nation's most vulnerable citizens, those facing death, is a concern shared by all of us and rises above partisan politics. This bill is good for Americans of all political persuasions.

We must educate our nation and our nation's health care providers in medical ethics, current law, and the principles and practice of palliative care and the incredible holistic work of hospice programs. This bill helps achieve this necessary education.

It is imperative that we develop a strong national response to oppose efforts to legalize assisted suicide and euthanasia and this bill sends a strong message that our government does not endorse the deliberate killing of patients. Passage of this legislation strengthens hospice and palliative care and says that our citizens, patients and physicians, need not resort to suicide and killing to achieve comfort and relief from distressing pain and symptoms.

I would urge you, members of this committee, and the entire Congress of the United States to continue to work with the hospice and palliative care communities to revolutionize the practice of hospice and palliative medicine. Let us commit to creating a comprehensive hospice and palliative care program for all of our citizens. Let us forge a new path with the Health Care Financing Administration and private insurance companies to ensure that all patients receive the finest in end-of-life care. Let us say to our citizens that no one must ever turn intentionally and deliberately to causing death because of pain, symptoms, or the effects of a terminal illness.

Amended H.R. 2260 is an excellent step in the direction of forging a system of care that embraces with true compassion those who face terminal illness. Let this bill become not an end to itself but the beginning of a national commitment to caring for our citizens in the final stages of their lives.

As a hospice and palliative care physician, I endorse this chairman's substitute. VistaCare Hospice, as a health care company that serves the interests of terminally ill and dying patients, believes that this chairman's substitute bill is consistent with our mission and values and that our patients will continue to receive state-of-the-art pain and symptom management while affirming their inherent dignity. This bill is an excellent beginning in providing the long overdue and too often neglected component of hospice and palliative care in our health care system as we enter this new century. Thank you for allowing me to be here.

Senator SESSIONS. Thank you, Dr. Hunter.

[The prepared statement of Dr. Hunter follows:]

PREPARED STATEMENT OF WALTER R. HUNTER, MD

Mr. Chairman, Members of the Committee, Ladies and Gentlemen: It is a privilege to be here today and to offer you my thoughts on Chairman's Substitute for House Resolution 2260. I am a full time hospice physician with VistaCare Hospice,

the second largest provider of hospice services in the United States. I have testified previously in favor of the Pain Relief Promotion Act and I return today to re-iterate my support, particularly in view of the current amended version you are now considering.

To briefly review my clinical background, I am certified in both internal medicine and hospice and palliative medicine. I have worked full time in hospice care for nearly four years. In that capacity, I have been involved in cases in which the side effects of medications may indeed contribute to the death of the patient. I have accepted these side effects as undesired effects in the true goal of providing pain and symptom relief. My use of controlled substances has always been dictated by the clinical circumstances. As a hospice physician I have never had any fear that my use of controlled substances could be interpreted erroneously as deliberately and intentionally killing my patients. I learned the clinical and ethical dimensions of palliative care long ago and can state that the oft-quoted ethical Principle of Double Effect is key and foundational to effective pain and symptom management.

The Principle of Double Effect is with me daily. It guides my actions as a physician and it keeps me honest in my actions. It is a viable ethical principle and it is the basis of this legislation's intent not to interfere with legitimate pain and symptom control.

Nothing in this bill will change what I do daily in my work as a hospice physician. Nothing in this bill will diminish our work at VistaCare to aggressively and adequately treat pain. Nothing in this bill frightens me that I will become a "target" of the DEA in a misguided attempt to prevent abuses of these controlled substances. Our patients at VistaCare will continue to receive as much morphine and other controlled substances as is necessary to control their pain and symptoms. On the contrary, this bill has the real potential to enhance our work in the communities we serve to promote palliative care, pain and symptom management, and a vision of end-of-life care which we believe is essential for our nation.

This bill has been accused by some in the medical community as merely a back door effort to thwart the development of assisted suicide and euthanasia for terminally ill patients. Some professionals have complained that it will discourage physicians from providing adequate pain relief for their patients because of fears of inappropriate scrutiny of medical practice by the Drug Enforcement Administration (DEA). Some believe it to be one more example of an intrusion by the Federal Government into the privacy of the physician-patient relationship and state jurisdiction over medical practice. I believe all of these concerns to be overstated and unfounded but they have been carefully examined by dedicated and knowledgeable professionals. The bill you have before you includes changes to address these concerns.

This legislation is, I believe, a timely, necessary, and explicit clarification of the existing Controlled Substances Act. Current CSA law does not allow for a physician to assist in suicide or to commit euthanasia; there are defined penalties for physicians who engage in diverting controlled drugs for non-medical uses and the Federal government has never regarded physician-assisted suicide or euthanasia as medical acts. However, Attorney General Janet Reno erred, in my opinion, when she ruled that existing CSA law was somehow invalid in Oregon just because Oregon has passed legislation allowing physician-assisted suicide. The current situation, therefore, is that I would face penalties for violation of the CSA if I practiced in 49 states and engaged in physician-assisted suicide, but I would not be subject to the same penalties if I lived in Oregon and committed the same act. Ladies and Gentleman, I am no legal scholar, but I thought I learned in grammar school that Federal law supercedes state law.

The legislation you have before you breaks no new legal ground. It does not authorize any new penalties for errant physicians. It does not grant the DEA any new powers for reviewing the use of controlled substances. It does not provide any excuse for a physician to under prescribe or fail to prescribe medications for pain and symptom relief. It merely brings Oregon under the same regulations affecting the other 49 states.

The authors of this amended legislation have heard the concerns and fears expressed in many arguments against this bill and have added further language to this bill that should satisfy all of its legitimate critics. This legislation clearly and definitely demarcates a line which is essential to the principles and practice of hospice and palliative care: It distinguishes philosophically and practically that there is, indeed, a difference between the aggressive management of symptoms even if death is an unfortunate outcome versus the deliberate and single-minded intention of killing a patient. The codification of the Principle of Double Effect in this legislation should be cause for celebration in the medical community. It grants to physicians express acknowledgement of the realities of the practice of pain and symptom control. It is an express acknowledgement that it is not that hard to distinguish the

legitimate use of controlled substances for legitimate medical reasons from the deliberate, intentional causation of death.

As an example of the work I am called to do daily, let me describe a case of a young AIDS patient I cared for a few years ago. On a Monday morning the hospice for whom I worked received a phone call from his family that he was having difficulty breathing. His nurse and I made a house call. When we entered the room we could hear his laborious and moist respirations across the room. His respiratory rate was 44 and he was unconscious. We immediately set to work. I gave him 40 mg of Lasix (furosemide)¹ intravenously. There was no effect. I then gave him 10 mg of morphine² intravenously. There was no effect after several minutes. I repeated the dose of 10 mg of morphine and waited several minutes. Again, there was no effect. I gave 5 mg of morphine. There was still no effect. I then gave 5 mg of Valium (diazepam) in an attempt to sedate him and ease the work of breathing. There was no effect. I repeated the Valium dose and there was still no effect. I gave 5 mg of morphine, waited, saw no effect and gave another 10 mg of morphine. After a few minutes, his respirations decreased to about 20. This was a reasonable goal. However, instead of stabilizing at 20, they continued to diminish and he stopped breathing several minutes later.

Did the fact that a respiratory rate of over 40 is terribly inefficient and allows toxins to build up in the body that can suppress respirations cause his death? Was he actively dying no matter what I did? Did the medications play a role in hastening the moment of death? Did I kill him? The answer is that the disease, his respiratory rate and the medications all may have combined to cause his death to occur a moment in time sooner than it would have occurred without my intervention. But I did not intend his death. I was using everything in my medical powers to ease the distress of his breathing. Had I deliberately wished his death, I would have given the Lasix, 40 mg of morphine and 10 mg of Valium as one immediate injection. Instead, I titrated the medicine against the clinical response I saw over the period of an hour. To apply the oft-quoted principle of Double Effect and apply it to this case would be useful in this example.

The Rule of Double Effect makes the following assertions:

1. *The Nature of the Act.* The act must be good, or at least morally neutral (independent of its consequences.)
2. *The Agent's Intention.* The agent intends only the good effect. The bad effect can be foreseen, tolerated, and permitted, but it must not be intended.³
3. *The Distinction Between Means and Effects.* The bad effect must not be a means to the good effect. If the good effect were the direct causal result of the bad effect, the agent would intend the bad effect in pursuit of the good effect.
4. *Proportionality Between the Good Effect and the Bad Effect.* The good effect must outweigh the bad effect. The bad effect is permissible only if a proportionate reason is present that compensates for permitting the foreseen bad effect.⁴

Using the above, let us analyze my patient utilizing each criterion from each perspective:

1. *The Nature of the Act.* The act (giving the patient the Lasix, morphine and Valium for the purpose of alleviating his respiratory distress) must be good, or at least morally neutral.

I would propose that his respiratory rate was too fast for any effective air exchange. This alone increased his risk of death not to mention how much discomfort it may have been causing him even though he appeared to be unconscious.⁵ Certainly, his family was present and to watch him gasp and labor for air was very

¹A diuretic that helps rid the body of salt and water by increasing excretion through the kidneys. This diuretic effect helps mobilize fluid out of the lungs and should theoretically improve the patient's breathing if fluid accumulation in the lungs is creating the breathing difficulty.

²Morphine is used in respiratory distress to ease the work of breathing.

³For an excellent look at the Principle of Double Effect and the role of intent, see Daniel Sulmasy, O.F.M., M.D., Ph. D., "The Use and Abuse of the Principle of Double Effect," *Clinical Pulmonary Medicine*, Vol. 3, No. 2, March, 1996.

⁴Beauchamp, Tom L. and Childress, James F. *Principles of Biomedical Ethics, 4th Edition*, Oxford University Press, New York, 1994.

⁵Interestingly, even though he was "unconscious," his family reported to me that when his two young nephews left the house earlier that morning with their father, they said to him from the door of the apartment, "Good bye, Uncle Joe." The family noted that upon hearing his name from the young boys he opened his eyes. In hospice work, we are convinced that patients are often able to experience the presence and hear the words of family and friends even though they (the patients) cannot effectively communicate their experience.

difficult for them. Therefore, the act of giving him the medicine was good from the clinical perspective.

2. *The Agent's Intention.* The agent (the physician—I, in this case) intends only the good effect. (The alleviation of his labored breathing.) The bad effect (possibly depressing his respirations or even causing his breathing to stop as a result of side effects of the medications) can be foreseen, tolerated, and permitted, but it must not be intended.

I knew that there was a slight risk of lethal side effects to the medications. But I knew that I might have to risk them, tolerate them in part or in totality if I were to attempt to ease his breathing. I did not intend for him to die, but I did intend to make his breathing easier. Had I intended the side effect of cessation of breathing, I would not have given incremental doses of medicine over time and observed his clinical response with each dose. I would have given a very large dose all at once to stop the breathing.⁶

3. *The Distinction Between Means and Effects.* The bad effect (the cessation of breathing) must not be a means to the good effect (ease in breathing.) If the good effect (ease in breathing) were the direct causal result of the bad effect, the agent would intend the bad effect in pursuit of the good effect.

Clearly, not breathing is not merely easier breathing. I intended only the effect of easing his breathing, not totally stopping his breathing. I, therefore, did not intend the bad effect in order to get the good effect.

4. *Proportionality Between the Good Effect and the Bad Effect.* The good effect (ease of breathing) must outweigh the bad effect (possible cessation of breathing as a side effect of medication.) The bad effect is permissible only if a proportionate reason is present that compensates for permitting the foreseen bad effect.

Unrelieved breathing at 44 times per minute without relief can become fatal in and of itself. It is certainly uncomfortable for any conscious individual as it is literally a sense of suffocation. The risk of side effects of the medicine would be permissible to alleviate the certainty of the discomfort and danger of his uncontrolled respiratory rate of 44.

In short, the Principle of Double Effect guided me through the decision making process and the actions I performed in this case. Chairman's Substitute for H.R. 2260 recognizes what I did in this case as legitimate palliative care, does not view my actions as assisting a suicide or committing euthanasia, and therefore protects me from prosecution for committing those acts.

This legislation establishes also that the United States government stands firm in its commitment to ensure that patients receive the very best there is available in palliative care but that the deliberate killing of those patients is neither endorsed nor encouraged by the United States government. It is not unreasonable for the Controlled Substances Act to prohibit physician-assisted suicide or euthanasia as a condition for maintaining a DEA license. All licenses carry certain privileges and certain restrictions. It is disingenuous to believe a DEA license should have no restraints.

In addition to all of these benefits, this legislation puts end-of-life care, pain and symptom management, and the care of our citizens in the spotlight at the center of the stage. While it certainly is not the final word in a proactive response to the needs of our aging population and dying patients, it is an important start. As we study our progress in further developing hospice, palliative care, and pain treatment for our citizenry, Congress will be called upon again to re-commit itself in principle and practice to ensuring comfort for all people who face serious or terminal illness. This legislation is a giant step toward that commitment.

As a physician, I am ashamed to admit that the vast majority of our nation's medical schools and residency programs have simply failed to make medical ethics, pain and symptom management priorities in their curricula. This information, however, is absolutely essential for physicians to properly provide excellent care for patients. Physicians can and must learn and understand thoroughly the Principle of Double Effect, and how that principle is incorporated into the clinical practice of palliative medicine and the intent of this legislation. This legislation provides for much needed education in the professional community. We at VistaCare applaud this bill for its commitment of monies for the advancement of understanding of palliative care and for the education of health care professionals in the principles and practice of palliative care. This commitment of time and money to these educational efforts will send

⁶Using the criteria of intent raised by Sulmasy in the article referenced above (Reference 5), had the patient not died, I would have felt relief and been happy. Additionally, by Sulmasy's criteria in analyzing my intent, I would then have calculated a dose of medication or combinations of medications based on my bedside work that morning which would have been designed to keep his breathing as comfortable as possible.

a very clear message that the United States Congress has taken up the cause of providing competent, compassionate, and comprehensive palliative care for our citizens who face life-threatening illness. This is an extremely important action both in concrete and symbolic terms. I extend to the sponsors of this bill my deepest gratitude for such a commitment. Passage of this bill will send a clear message that the care of many of our nation's most vulnerable citizens—those facing death—is a concern shared by all of us and rises above partisan politics. This bill is good for Americans of all political persuasions.

We must educate our nation and our nation's health care providers in medical ethics, current law, and the principles and practice of palliative care and the incredible holistic work of hospice programs. This bill helps achieve this necessary education. It is imperative that we develop a strong national response to oppose efforts to legalize assisted suicide and euthanasia and this bill sends a strong message that our government does not endorse the deliberate killing of patients. Passage of this legislation strengthens hospice and palliative care, and says that our citizens—patients and physicians—need not resort to suicide and killing to achieve comfort and relief from distressing pain and symptoms.

I would urge you, Mr. Chairman, members of this committee and the entire Congress of the United States to continue to work with the hospice and palliative care communities to revolutionize the practice of hospice and palliative care in our nation. Let us commit to creating a comprehensive hospice and palliative care program for our citizens. Let us forge a new path with the Health Care Financing Administration and private insurance companies to ensure that all patients receive the finest in end-of-life care. Let us say to our citizens that no one must ever turn intentionally and deliberately to causing death because of pain, symptoms or the effects of a terminal illness. Chairman's Substitute for H.R. 2260 is an excellent step in the direction of forging a system of care that embraces with true compassion those who face terminal illness. Let this bill become not an end to itself, but the beginning of a national commitment to caring for our citizens in the final stages of their lives.

As a hospice and palliative care physician, I endorse this Chairman's Substitute for H.R. 2260. VistaCare Hospice, as a health care company that serves the interests of terminally ill and dying patients, believes that this Chairman's Substitute is consistent with our mission and vision that patients receive state-of-the-art pain and symptom management while affirming their inherent dignity. This bill is an excellent beginning in providing the long overdue and too often neglected component of hospice and palliative care in our health care system as we enter the new century.

Thank you for allowing me to be here today.

Senator SESSIONS. Thank you to members of the panel. I think it was an important dialogue that we have had and I look forward to continuing it.

I think perhaps we all bring to this Senate when we are elected our own values, beliefs, concepts about what is important. Recently, an individual criticized me in the paper by saying that Sessions had let his moral values interfere with his good judgment. [Laughter.]

I do not know what that meant. A friend of mine wrote me a letter and was rather amused by it. So I think we all bring that here.

One of our leaders in this Senate, Senator Grassley, I will turn to you at this time.

Senator GRASSLEY. Thank you very much. I want to be up front with all of you and tell you what you probably already know, and that is that I am a cosponsor of Senator Nickles' legislation, and I know it is a highly controversial piece of legislation.

I would start with Dr. Chevlen and I would ask you to respond to an argument that Dr. Caplan made that the Pain Relief Promotion Act will have a chilling effect on physicians treating patients for pain. I would like to have you comment in light of your experiences in States that have passed similar pieces of legislation to this one.

Dr. CHEVLEN. This question deserves an answer, Senator. The question is, would passage of a PRPA bill, either nationally or on a State level, deter physicians from prescribing adequate pain relief medicine? Would it have a chilling effect?

This is a testable hypothesis and one which has been tested in the laboratory of the States. There are six States which have recently passed laws which are identical in impact to this Federal law. In all of those States, we see that morphine consumption actually increased. It did not decrease.

I have the graphs here, but it might be easier for people to see if those were displayed. Now, this rising use of morphine in States which have passed PRPA-type legislation does not prove that passing PRPA legislation improves pain control. What it does disprove, however, is that it worsens pain control, and that was the issue before us.

The graph you see now is the morphine consumption per capita in Iowa and how it rose after PRPA-type legislation was passed there.

Senator SESSIONS. It looks from that chart that it more than doubled since the passage in 1995 of the Act.

Dr. CHEVLEN. Yes, sir. Similar data are available for five other States, but I think that makes the point.

Senator GRASSLEY. Dr. Foley, I am going to ask you to be kind of a referee here. We heard the argument from you that this legislation would expand the authority of the Controlled Substances Act, and yet, as you probably know, we have the AMA, the Justice Department, and the National Hospice and Palliative Care Organizations all concluding that the legislation would actually reduce the authority of the Controlled Substances Act over pain control and provide physicians with a clearer protection from legal liability than existed before. How do you suggest that we resolve those differences of opinion?

Dr. FOLEY. I think it matters on who you ask. There was a survey in an attempt to address this issue in New York State to look at how regulatory practices in New York State, these strict regulations that we have, impacted physician practice. Really, I think almost to my own amazement, was the fact that physicians consistently under-prescribed pain medications to patients with cancer and even further under-prescribed prescriptions to patients with noncancer.

As much as the discussion here has focused on end-of-life care, I really come here as an advocate for the patient with pain at the continuum of their illness, and one of the major problems in this country is not simply the under-treatment of patients at the end of life but the under-treatment of patients throughout the course of their illness. And one of the major barriers has been a very strict regulatory environment.

The Controlled Substance Act very clearly now says that it supports the use of these medications for legitimate medical practices. I think that the issue here is not a legal issue but it is much more of a medical issue of physicians who are profoundly undereducated in the evaluation and treatment of patients with pain and physicians who are profoundly undereducated in palliative care. We

have had so much data, and the Institute of Medicine has summarized this for you.

So to pass a law that really is not addressing the problem will not add anything, and my great concern is that it does, every increased level of regulation, any possibility that the Drug Enforcement Agency could be at the bedside of the patient, has an impact on clinicians who are uneducated and untrained in addressing the needs of patients in this area.

Senator GRASSLEY. Thank you very much for your answer.

Dr. Hunter, you discussed the principle of double effect and you used this principle to explain the underlying intent of a physician's action. Is the principle of double effect part of a standard medical school curricula? Is it something every physician is expected to know and to understand?

Dr. HUNTER. It was certainly not explicitly taught to me when I was in medical school or residency training. I would, without having the specific information available, I would go out on a limb and say that, no, it is probably not being taught explicitly in the vast majority of our schools. It is implied in many things, and, in fact, it is implied in virtually everything we do as a physician. It is just that physicians do not recognize it as such.

To give a very, very clear example, if you were to come to see me and I had an indication to give you penicillin and I took a history and that you had no prior history of allergy to penicillin and you went home and took the penicillin and you suddenly had an anaphylactic reaction and died, I could invoke double effect. I did not intend for that. That is a recognized risk with the treatment, but the treatment is indicated. Now, I would certainly be held liable had I failed to take a drug history from you.

But I think physicians do not understand it and I think that Dr. Foley is absolutely correct. We have an abysmal situation in our medical schools and our residency programs. As Dr. Foley has said, I think it does depend on whom you ask.

My recommendation for this is that every physician in this country immediately be brought into the 21st century in pain and symptom management. The tools are out there. The experts are there, so that we just need to have a concentrated national effort to get physicians to do the right things. I was grossly undertrained in pain and symptom management and I was one of those physicians under-treating patients until I did some independent study and learned how to do this. I promise you, it is not rocket science. If I can learn it, anyone can learn it.

Senator GRASSLEY. Thank you. Thank you, Mr. Chairman.

Senator SESSIONS. Senator Wyden.

Senator WYDEN. Thank you very much, Mr. Chairman. Again, let me express my thanks to you.

I will start with you, if I could, Dr. Caplan. I got a fax from the DEA that indicates to me that in the substitute that will be voted on on Thursday in the committee, that the Federal Government would be able to spend up to \$80 million a year investigating physicians for potential violations of this law. The amount that the substitute sets aside for palliative care is \$5 million. So what the committee will vote on on Thursday is a measure that, in effect, al-

lows 16 times the resources to be devoted to investigating physicians as we would have to promote pain relief.

You have said the pain relief movement is very fragile in this country. What message does the Senate send if it passes that on Thursday?

Mr. CAPLAN. I think the message is loud and clear. To me, the message will be heard as, avoid the threat of abuse of addictive and risky pain control drugs. Do not take the relief of pain as your top priority. And I think, ethically, what the dying cannot often protect their own interest and families, who are often, if you will, beside themselves because of the emotional burden that befalls family members when they are trying to care for the dying in an acute care setting, often with unexpected illness, they cannot insist that pain take priority. So the message will be the authorities are going to keep an additional eye over your shoulder. Be cautious.

And I fear, given the fragile nature of what we are trying to do to move medicine along to do what we all agree on this panel must be done, make pain control, and suffering relief, I might add, top priorities of care, that that will be inimical. That budget allotment will be inimical to that laudatory goal.

Senator WYDEN. Just a couple of others very briefly, Mr. Chairman.

Dr. Foley, for you, if I might, you are a physician living in rural Oregon, rural Iowa, rural Alabama. The under-treatment of pain is already a documented public health crisis. The Federal Government with the substitute now has the authority to dissect a physician's intent with respect to their prescribing practices. What is going to go through a doctor's mind when they think about reaching for that prescription pad to write a prescription not for anything to do with assisted suicide but just for pain relief? What is going to go through that physician's mind if this bill becomes law?

Dr. FOLEY. Well, whether the bill becomes law or not, what goes through their minds now is—they are not educated in caring for patients and the overwhelming strict regulatory environment that we have had has made them very fearful of prescribing drugs, and in Oregon, made them very fearful. Oregon had very strict regulatory practices that only recently have changed.

The physician is at the bedside trying to do the right thing for the patient and has not been educated to do the right thing for the patient. So I think more likely what we are seeing is doctors do not have DEA licenses and what they say to their patients is, I cannot treat your pain and I cannot provide opioids because I do not have a DEA license, and that is how they are getting around this issue.

Senator WYDEN. One last question, Mr. Chairman. Another significant difference in my mind, Dr. Caplan, between the substitute, the measure I developed with Senator Mack and Senator Smith and what will be voted on on Thursday, involves families and including families in these difficult decisions. We have in our bipartisan bill support for family support networks that mobilize families for the first time in trying to participate in these decisions, and I know all of you have seen in your practice a family can be with a patient, say, on a Sunday and the patient is in agony and they cannot get help for the person. They call, and call back during normal business hours.

So we want to, 24 hours a day, every day of the year, have families in a position to get help for the suffering, and this is a difference between the substitute and our legislation. I wonder if you would just comment for a moment on the role of families, empowering them as we look at this issue, Dr. Caplan.

Mr. CAPLAN. Well, I have been interested for a long time in what happens at the end of life, and what we do in our country is we tend to say that we will establish individual rights, individual controls, and respect personal choice and autonomy about managing one's dying. We usually add to that what we have heard about a little bit, the commission and omission standard as governing what the doctor can do. But we have established a lot of authority over how ones dies, establishing the right to withdraw treatment, forego treatment, withhold treatment.

What we have a harder time understanding is that when people are dying, the family plays a crucial role because your autonomy is diminishing and it is hard to assert that power when you are impaired, when you become cognitively damaged, and when you are just in emotional and spiritual turmoil as part of the dying process. Some can do it, some cannot.

So it is absolutely crucial, and I think the lesson, if you will, of the living will is you can fill out documents and say what you wish, but if your family and those who love you are not present and able to assert their authority and power when you are dying, you will not have your wishes respected. The family is the lever. It really is the tool that will make sure that your wishes get respected, that what you want is going to be acted on when you have a harder time expressing yourself.

So I absolutely support that emphasis. I think it is crucial. Ironic as it may be, I think the road to individual autonomy lies through creating empowerment for the people who are present when that is somewhat jeopardized by serious illness and fatal illness.

Senator WYDEN. Thank you, Mr. Chairman.

Senator SESSIONS. Thank you, Senator.

Rabbi Bleich, in your experience and your best judgment, is this a major issue for this culture? Is this a big deal decision, whether or not we would give governmental imprimatur to having physicians assist in the death of a patient?

Rabbi BLEICH. In an age of declining emphasis upon moral values, this is a major matter. It is a question of enunciating public policy and through public policy public morals and values. Allowing the Federal license to be used for administering drugs designed to shorten life sends a very, very significant moral message. It says that our Federal Government does not recognize that as a matter which should be precluded by law. In effect, it establishes a climate of opinion in which there is an endorsement of that type of activity as reflective of values and mores that are acceptable to the public at large.

I doubt very much, as I said before, that the passage of the bill will prevent as much as a single suicide. It does have a very significant effect not in how physicians will administer these drugs, but it has a very significant effect upon the moral climate of this country, and I think that that is a matter of even graver importance.

Senator SESSIONS. In the history of a Judeo-Christian culture and Western civilization, are you aware of any state-authorized act by which suicide is justified or supported? Would this be unusual in that regard?

Rabbi BLEICH. It would be extremely unusual.

Senator SESSIONS. I know Oregon has voted on this bill, and Rabbi, if it is a wrong, I am, as a prosecutor, Federal prosecutor for 15 years, inclined to believe that Director Constantine was correct in his analysis of the law. The Attorney General saw otherwise, but I believe, my best judgment, without pounding the table too hard, is that his opinion was more correct legally. It strikes me that I have a moral duty at this point. I cannot defer to Oregon, and neither can any Senator here defer to Oregon. There is a Federal law that either does prohibit this act or a bill pending before us that would prohibit it. So in terms of denying responsibility, would you say that it would be inappropriate for us to deny our responsibility when we make a decision?

Rabbi BLEICH. Let me say, Senator, that I fully agree with you that as a matter of law, your interpretation of the statute is correct and the Attorney General's is not. But unfortunately, it is the Attorney General's interpretation of the statute that has prevailed, so that to all intents and purposes, the Act as it is now written and is now enforced is the Act as interpreted by the Attorney General. In effect, Congress is now being asked to substitute its understanding of the original intent of the law for that of the Attorney General.

And yes, I think that it would be a moral duty for anyone in a position of authority, for anyone in a position to cast a vote with regard to this Act, to vote and assert his authority in a manner which would be consistent with public morality.

Senator SESSIONS. Dr. Chevlen, does this Act not explicitly provide for pain relief treatment even if it were to shorten life, and is that not a greater protection for the physicians than they would now have under current law?

Dr. CHEVLEN. Senator, that is in the law by—

Senator SESSIONS. Here is the language. It says, "For the purposes of this Act, alleviating pain or discomfort in the usual course of professional practice is a legitimate medical purpose for the dispensing, distributing, or administering of a controlled substance that is consistent with public health and safety, even if the use of such a substance may increase the risk of death."

Dr. CHEVLEN. Senator, every day of my practice since I left medical school, I have been practicing under that law because that has been the law since the CSA was established, but it was the law by administrative guideline. This bill before us elevates that to the level of statute and actually decreases, not increases, DEA oversight, or possible DEA oversight. By raising the standard of proof necessary from the current level, it actually makes it more difficult for the DEA to interfere, not less difficult, and therefore should have an ameliorating effect on a willingness of a doctor to use proper quantities of proper medicine.

Senator SESSIONS. And would it give explicit statutory protection to a physician who had, as Dr. Caplan mentioned, a relative charg-

ing in at the last moment to complain? Would not that physician feel somewhat more protected with this Act than not?

Dr. CHEVLEN. It is certainly better than a regulatory guideline.

Senator SESSIONS. I would just say this about the dissecting of a doctor's intent or the suggestion that the DEA would be at the patient's bedside. I think that is very overdrawn and language that would not be correct. As an attorney who prosecuted several physicians for deliberately dealing in selling drugs illegally, I know how difficult it is because a physician is given extraordinary discretion in what they need to do to distribute drugs. I think if you had to have a case under this Act, you would have to have evidence that this physician knew that the amount of drugs he was prescribing and giving would inevitably result in death in a short period of time. That is just my basic view of it. And I think physicians do not need to worry that the Federal Government and the DEA is going to be in their prescribing rooms or in the hospital rooms concerning this.

I would also point out that the American Medical Association has supported this bill, which I do. The Medical Association of the State of Alabama has written recently to me that they are squarely opposed to—well, they say, “The Alabama Association and the American Medical Association are squarely opposed to physician-assisted suicide and believe it is antithetical to the role of a physician as healer,” and they go on to endorse this specific Act with the amendments that are here.

So I believe we move forward in a way that has identified our problems and the concerns that physicians have and tried to address those, at least I am pleased that the sponsors of this bill have, and I hope we are moving in that direction.

Senator GRASSLEY, would you like another round?

Senator GRASSLEY. I have no further questions.

Senator SESSIONS. Senator Wyden.

Senator WYDEN. No.

Senator SESSIONS. Again, let me say how much I appreciate your contribution to this discussion. I do believe this is a matter of importance. It is not an itty-bitty thing, as Senator Hatch is wont to say on occasion. It is a matter that we need to take seriously. You have added immensely to our ability to analyze it. I am supportive of this Act. I believe a majority will be. Thank you.

If anyone has any questions, they may submit them for the record, and we thank you all.

We are adjourned.

[Whereupon, at 11:20 a.m., the committee was adjourned.]

A P P E N D I X

PROPOSED LEGISLATION

HB

106TH CONGRESS
1ST SESSION

H. R. 2260

IN THE SENATE OF THE UNITED STATES

OCTOBER 28, 1999

Received

NOVEMBER 19, 1999

Read twice and referred to the Committee on the Judiciary

AN ACT

To amend the Controlled Substances Act to promote pain management and palliative care without permitting assisted suicide and euthanasia, and for other purposes.

1 *Be it enacted by the Senate and House of Representa-*
2 *tives of the United States of America in Congress assembled,*

1 **SECTION 1. SHORT TITLE.**

2 This Act may be cited as the "Pain Relief Promotion
3 Act of 1999".

4 **TITLE I—USE OF CONTROLLED**
5 **SUBSTANCES CONSISTENT**
6 **WITH THE CONTROLLED SUB-**
7 **STANCES ACT**

8 **SEC. 101. REINFORCING EXISTING STANDARD FOR LEGITI-**
9 **MATE USE OF CONTROLLED SUBSTANCES.**

10 Section 303 of the Controlled Substances Act (21
11 U.S.C. 823) is amended by adding at the end the fol-
12 lowing:

13 "(i)(1) For purposes of this Act and any regulations
14 to implement this Act, alleviating pain or discomfort in
15 the usual course of professional practice is a legitimate
16 medical purpose for the dispensing, distributing, or admin-
17 istering of a controlled substance that is consistent with
18 public health and safety, even if the use of such a sub-
19 stance may increase the risk of death. Nothing in this sec-
20 tion authorizes intentionally dispensing, distributing, or
21 administering a controlled substance for the purpose of
22 causing death or assisting another person in causing
23 death.

24 "(2) Notwithstanding any other provision of this Act,
25 in determining whether a registration is consistent with
26 the public interest under this Act, the Attorney General

1 shall give no force and effect to State law authorizing or
2 permitting assisted suicide or euthanasia.

3 “(3) Paragraph (2) applies only to conduct occurring
4 after the date of the enactment of this subsection.”.

5 **SEC. 102. EDUCATION AND TRAINING PROGRAMS.**

6 Section 502(a) of the Controlled Substances Act (21
7 U.S.C. 872(a)) is amended—

8 (1) by striking “and” at the end of paragraph
9 (5);

10 (2) by striking the period at the end of para-
11 graph (6) and inserting “; and”; and

12 (3) by adding at the end the following:

13 “(7) educational and training programs for
14 local, State, and Federal personnel, incorporating
15 recommendations by the Secretary of Health and
16 Human Services, on the necessary and legitimate
17 use of controlled substances in pain management
18 and palliative care, and means by which investiga-
19 tion and enforcement actions by law enforcement
20 personnel may accommodate such use.”.

1 **TITLE II—PROMOTING**
2 **PALLIATIVE CARE**

3 **SEC. 201. ACTIVITIES OF AGENCY FOR HEALTH CARE POL-**
4 **ICY AND RESEARCH.**

5 Part A of title IX of the Public Health Service Act
6 (42 U.S.C. 299 et seq.) is amended by adding at the end
7 the following section:

8 **“SEC. 906. PROGRAM FOR PALLIATIVE CARE RESEARCH**
9 **AND QUALITY.**

10 “(a) IN GENERAL.—The Administrator shall carry
11 out a program to accomplish the following:

12 “(1) Develop and advance scientific under-
13 standing of palliative care.

14 “(2) Collect and disseminate protocols and evi-
15 dence-based practices regarding palliative care, with
16 priority given to pain management for terminally ill
17 patients, and make such information available to
18 public and private health care programs and pro-
19 viders, health professions schools, and hospices, and
20 to the general public.

21 “(b) DEFINITION.—For purposes of this section, the
22 term ‘palliative care’ means the active, total care of pa-
23 tients whose disease or medical condition is not responsive
24 to curative treatment or whose prognosis is limited due
25 to progressive, far-advanced disease. The purpose of such

1 care is to alleviate pain and other distressing symptoms
2 and to enhance the quality of life, not to hasten or post-
3 pone death.”.

4 **SEC. 202. ACTIVITIES OF HEALTH RESOURCES AND SERV-**
5 **ICES ADMINISTRATION.**

6 (a) IN GENERAL.—Part D of title VII of the Public
7 Health Service Act (42 U.S.C. 294 et seq.), as amended
8 by section 103 of Public Law 105-392 (112 Stat. 3541),
9 is amended—

10 (1) by redesignating sections 754 through 757
11 as sections 755 through 758, respectively; and

12 (2) by inserting after section 753 the following
13 section:

14 **“SEC. 754. PROGRAM FOR EDUCATION AND TRAINING IN**
15 **PALLIATIVE CARE.**

16 “(a) IN GENERAL.—The Secretary, in consultation
17 with the Administrator for Health Care Policy and Re-
18 search, may make awards of grants, cooperative agree-
19 ments, and contracts to health professions schools, hos-
20 pices, and other public and private entities for the develop-
21 ment and implementation of programs to provide edu-
22 cation and training to health care professionals in pallia-
23 tive care.

1 “(b) PRIORITIES.—In making awards under sub-
2 section (a), the Secretary shall give priority to awards for
3 the implementation of programs under such subsection.

4 “(c) CERTAIN TOPICS.—An award may be made
5 under subsection (a) only if the applicant for the award
6 agrees that the program carried out with the award will
7 include information and education on—

8 “(1) means for alleviating pain and discomfort
9 of patients, especially terminally ill patients, includ-
10 ing the medically appropriate use of controlled sub-
11 stances;

12 “(2) applicable laws on controlled substances,
13 including laws permitting health care professionals
14 to dispense or administer controlled substances as
15 needed to relieve pain even in cases where such ef-
16 forts may unintentionally increase the risk of death;
17 and

18 “(3) recent findings, developments, and im-
19 provements in the provision of palliative care.

20 “(d) PROGRAM SITES.—Education and training
21 under subsection (a) may be provided at or through health
22 professions schools, residency training programs and other
23 graduate programs in the health professions, entities that
24 provide continuing medical education, hospices, and such

1 other programs or sites as the Secretary determines to be
2 appropriate.

3 “(e) EVALUATION OF PROGRAMS.—The Secretary
4 shall (directly or through grants or contracts) provide for
5 the evaluation of programs implemented under subsection
6 (a) in order to determine the effect of such programs on
7 knowledge and practice regarding palliative care.

8 “(f) PEER REVIEW GROUPS.—In carrying out section
9 799(f) with respect to this section, the Secretary shall en-
10 sure that the membership of each peer review group in-
11 volved includes one or more individuals with expertise and
12 experience in palliative care.

13 “(g) DEFINITION.—For purposes of this section, the
14 term ‘palliative care’ means the active, total care of pa-
15 tients whose disease or medical condition is not responsive
16 to curative treatment or whose prognosis is limited due
17 to progressive, far-advanced disease. The purpose of such
18 care is to alleviate pain and other distressing symptoms
19 and to enhance the quality of life, not to hasten or post-
20 pone death.”.

21 (b) AUTHORIZATION OF APPROPRIATIONS; ALLOCA-
22 TION.—

23 (1) IN GENERAL.—Section 758 of the Public
24 Health Service Act (as redesignated by subsection
25 (a)(1) of this section) is amended in subsection

1 (b)(1)(C) by striking “sections 753, 754, and 755”
2 and inserting “sections 753, 754, 755, and 756”.

3 (2) AMOUNT.—With respect to section 758 of
4 the Public Health Service Act (as redesignated by
5 subsection (a)(1) of this section), the dollar amount
6 specified in subsection (b)(1)(C) of such section is
7 deemed to be increased by \$5,000,000.

8 **SEC. 203. EFFECTIVE DATE.**

9 The amendments made by this title take effect Octo-
10 ber 1, 1999, or upon the date of the enactment of this
11 Act, whichever occurs later.

Passed the House of Representatives October 27,
1999.

Attest:

JEFF TRANDAHL,

Clerk.

ADDITIONAL SUBMISSIONS FOR THE RECORD

HYMAN, PHELPS & McNAMARA, P.C.,
Washington, DC, October 18, 1999.

JAMES A. GUEST,
Executive Director, American Pain Foundation,
Baltimore, MD.

DEAR MR. GUEST: You have asked my opinion on the potential impact of S. 1272, the "Pain Relief Promotion Act of 1999" (the "PRPA"), introduced by Senator Nickles and its companion bill H.R. 2260, introduced by Representative Hyde, on the use of controlled substances for palliative care. I have limited my opinion to an analysis of Title I which amends section 303 of the Controlled Substances Act (CSA). Also, this opinion is based on a review of the current law, DEA's policy in regard to practitioner registrations and my experience as a former attorney in the Drug Enforcement Administration's (DEA's) Office of Chief Counsel.

The PRPA provides that a practitioner's dispensing, distributing or administering of controlled substances to assist in suicide would be against the public interest without regard to state law or medical standards. The bill acknowledges that providing controlled substances for palliative care, even if it hastens death, is legitimate medical care. It defines such care, however, within the context of physician-assisted suicide and judgments about a physician's intent. Consequently, the bill inappropriately expands DEA authority to evaluate the practice of medicine as it pertains to pain management. DEA will be required to interpret a physician should be registered under the Controlled Substances Act (CSA). The Department of Justice and DEA have recently rejected such subjective decision making on the part of the agency in issues related to pain management. The PRPA does not improve the standards for palliative care and may make physicians hesitant to prescribe controlled substances in treatment of severe pain for fear of the potential criminal, civil and administrative penalties.

1. *Current law and DEA regulations and policy already acknowledge that prescribing controlled substances is appropriate in the treatment of pain.*

The relevant law and the courts recognize the legitimacy of prescribing controlled substances for palliative care. The CSA and DEA regulations provide that physicians have an obligation to treat those suffering from intractable pain. The CSA states that many controlled substances have a "useful and legitimate medical purpose and are necessary to maintain the health and general welfare of the American people." 21 U.S.C. § 801(1). In DEA's Physician's Manual, (March 1990) the agency asserts that:

[c]ontrolled substances and, in particular, narcotic analgesics, may be used in the treatment of pain experienced by a patient with a terminal illness or chronic disorder. These drugs have a legitimate clinical use and the physician should not hesitate to prescribe, dispense or administer them when they are indicated for a legitimate medical purpose. It is the position of the Drug Enforcement Administration that these controlled substances should be prescribed, dispensed or administered when there is a legitimate medical need.

DEA Physician's Manual at 21.

Even where the CSA requires a special registration for prescribing of controlled substances for addiction treatment, DEA regulations state that there is no intent to limit a physician's prescribing for intractable pain. 21 C.F.R. § 1306.07. The U.S. Supreme Court has also recognized that patients suffering from a terminal illness have a right to palliative care even if it hastens death. *Glucksberg v. Washington*, 117 S.Ct 2258 (1997); *Quill v. Vacco*, 117 S.Ct 2293 (1997).

Therefore, there is no ambiguity in the law or DEA policy as to whether prescribing controlled substances for pain management is appropriate medical care, even in large doses where necessary. However, the problem lies in the implementation.

2. *The PRPA would contradict DOJ and DEA's findings that the agency should defer to the medical community on the appropriate standards for prescribing for palliative care.*

There is no argument about the fact that DEA has the authority to deny or revoke a practitioner's registration where the physician has unlawfully prescribed con-

trolled substances. DEA regulations require that physicians only issue prescriptions for a legitimate medical purpose and in the usual course of professional practice. 21 C.F.R. § 1306.05. In addition, DEA can deny or revoke a registration where a physician fails to follow either federal or state regulations on either substantive or procedural (i.e., recordkeeping) requirements for prescribing of controlled substances. (See e.g., Robert L. Dougherty, Jr., M.D., 60 Fed. Reg. 55047 (1995); Harland J. Borchering, D.O., 60 Fed. Reg. 28796 (1995)) DEA registrants can also be criminally prosecuted where “their activities fall outside the course of professional practice.” *United States v. Moore*, 423 U.S. 122 (1975).

In fulfilling these responsibilities, DEA has determined in several recent cases that the agency should not make subjective decisions on appropriate prescribing for pain management.

In 1995, DEA issued two final orders (Skinner & Roth) involving the investigations of two physicians for inappropriately prescribing opioids to the same patient for intractable pain. 60 Fed. Reg. 62262 (Dec. 5, 1995); 60 Fed. Reg. 62887 (Dec. 7, 1995). DEA investigators alleged that the physicians inappropriately prescribed excessive quantities of controlled substances for no legitimate medical purpose. It was further alleged that the physicians inappropriately prescribed them to a narcotic dependent person to maintain or detoxify the patient. The patient, who had several legitimate medical conditions that caused acute and chronic pain, ultimately was admitted to the Betty Ford Clinic with a diagnosis of dependency on opiates, alcohol, sedatives and amphetamines.

A hearing was conducted on the revocation of these physicians’ DEA registrations.

The physicians presented expert testimony demonstrating that they had followed state guidelines on prescribing for chronic pain and that the prescribing was appropriate. The administrative Law Judge (ALJ) who heard the cases recommended against revocation of their registrations. The DEA Deputy Administrator ultimately agreed with the ALJ and did not revoke the registrations. Significantly, the Deputy Administrator concluded that:

The conflicting expert opinion evidence presented leads to the conclusion that the medical community has not reached a consensus as to the appropriate level of prescribing of controlled substances in the treatment of chronic pain patients. Given this dispute, the Deputy Administrator is reluctant to conclude that the Respondent’s prescribing of controlled substances to Patient A lacked a legitimate medical purpose or was outside the usual course of professional practice. It remains the role of the treating physician to make medical treatment decisions consistent with a medical standard of care and the dictates of Federal and State law.

60 Fed. Reg. at 62267, 62891.

More recently, the agency reiterated that it would be inappropriate for DEA officials to impose their subjective definition for legitimate medical care in the context of pain management. At issue in the case of Paul W. Saxton, M.D. 64 Fed. Reg. 25,073 (May 10, 1999), were 38 medical records for patients treated for chronic pain. A pharmacist complained to the State Board because the physician had prescribed six different controlled substances to one individual. DEA and state investigators seized 38 patient records as a result of a review of the physician’s prescription profiles from several local pharmacies.

Both the government and the physician provided expert testimony at the hearing. In ruling for the physician, the DEA Deputy Administrator found that the prescriptions were justified based on several factors, including a review of the patient charts, testimony from the physician, patients and experts, and reports from specialists. The DEA also found that the experts had all testified that there is no upper limit on the use of narcotics in the treatment of chronic pain. The Deputy Administrator rejected the government’s argument that the physician should have reduced the dosage levels. Both the ALJ and DEA Deputy Administrator concluded that:

It is apparent that there is a disagreement within the medical community regarding the use of controlled substances in the treatment of chronic pain. . . . DEA is in a difficult position, for it is asked to determine the appropriate prescribing practices in the treatment area in which the medical profession is not in accord: the treatment of chronic pain patients. . . . *[It] is not DEA’s role to resolve this disagreement.* It remains the role of the treating physician to make medical treatment decisions consistent with a medical standard of care and the dictates of the Federal and State law.

Saxton at 25,079 (emphasis added).

The PRPA contradicts DEA’s policy that the agency should defer to the medical community on the appropriate standards for prescribing for pain. By attempting to

define "legitimate medical purpose," the PRPA would expand the DEA's authority to question a physician's decision in prescribing controlled substances, even when it is within state medical guidelines. This would logically include closer scrutiny by federal investigators of decisions by physicians to prescribe and administer pain medication, particularly when these decisions increase the risk of death. Yet DEA has repeatedly asserted that it is not qualified to make such decisions. The fact that the PRPA would authorize federal authorities to promulgate rules for palliative care would attempt to establish a federal medical standard. This would create further conflicts especially because many states have already adopted legislative standards for intractable pain. Given that establishing medical standards has been left to the states and is regulated by the states, DEA should not now begin to impose a separate medical standard.

3. *The PRPA will increase DEA scrutiny of physician's palliative care.*

The PRPA would establish a federal criteria for "legitimate medical purpose" under the CSA, that is, the use of controlled substances for alleviating pain or discomfort even if it increases the risk of death. This is a departure from current law that would defer to state medical standards and could create a conflict with state medical guidelines as to the appropriate standard of medical care. The PRPA attempts to determine what is and what is not a legitimate medical purpose in the context of prescribing controlled substances for pain but leaves to DEA the decision to determine the intent of a physician's action. This would establish a dangerous precedent for the DEA to dictate whether certain medical care is a "legitimate medical purpose" where state authorities have determined otherwise.

Writing this standard into the CSA creates an obligation for DEA to investigate and question the intent of physicians in prescribing controlled substances for pain management. The result will necessarily be an increase in DEA scrutiny of physicians treating patients for severe pain where death has occurred. Physicians will be concerned that DEA investigators will see criminal intent where there is none.

4. *Practitioners will incur the costs and burden of justifying their medical care to federal authorities.*

The increased scrutiny by DEA as a result of the PRPA will require physicians to incur costs to justify their prescribing of controlled substances. These costs can be significant in the context of a criminal or civil investigation or even in the context of a DEA administrative proceeding on the denial of a DEA registration. Such costs include hiring counsel and experts to defend a potential licensing proceeding on prescribing of controlled substances. The record reflects that in the *Saxton* case, the physician hired at least two experts and that the administrative hearing lasted for 12 days.

5. *Congress should not link palliative care with physician assisted suicide in the context of the CSA public interest standard.*

In juxtaposing the issue of palliative care which may result in death with physician-assisted suicide, the PRPA makes it more likely that physicians will come under increased scrutiny as to their intent on prescribing large doses of narcotic drugs for palliative care. Moreover, focusing this debate within the context of whether a practitioner's DEA registration is in the public interest increases the change that physicians will be hesitant to treat patients aggressively for severe pain. Physicians will fear a potential flood of complaints directed to federal authorities as to whether they have met an appropriate standard of care. Physician-assisted suicide involves broad policy issues beyond the determination of whether a physician is qualified to prescribe controlled substances.

In conclusion, the PRPA will in fact not create new protections for the treatment of pain nor does the CSA need to be changed to protect practitioners. What is needed is appropriate implementation of existing policies. The PRPA does not accomplish this. On the contrary it may raise new barriers by expanding DEA authority to investigate and question the intent of physicians and the practice of medicine as it applies to palliative care, a result clearly not intended by the CSA or established DEA policy. Under the PRPA physicians would be hesitant to prescribe large doses of pain medication, particularly where death may result in the short or long term, because of the potential for criminal, civil or even administrative sanctions. This will contribute to the continued problem of undertreatment of pain.

If it is Congress's intent to prohibit physician-assisted suicide, it should do so with legislation directed at providing criminal penalties for this activity rather than to limit the public interest criteria under the CSA and thereby negatively affect the prescribing of controlled substances for the legitimate treatment of pain. The sections in Title I of the bill dealing with palliative care should be removed in order to avoid the unintended effect of limiting patient care. The issue of palliative care

would be better dealt with in comprehensive legislation such as the “The Conquering Pain Act,” (S. 941 and H.R. 2188) or other legislation that truly promotes treatment of pain.

Sincerely,

JOHN A. GILBERT, Jr.

HARVARD LAW SCHOOL,
Cambridge, MA, April 10, 2000.

Re H.R. 2260, the Pain Relief Promotion Act of 1999.

Hon. EDWARD KENNEDY,
315 Russell Senate Office Building, Washington, DC.

DEAR SENATOR KENNEDY: We are writing to you to urge your continued opposition to H.R. 2260, the Pain Relief Promotion Act of 1999. We are, respectively, a professor of criminal law and former Dean at Harvard Law School, a professor of health law and constitutional law at Boston College Law School, and a Boston attorney who formerly represented the Massachusetts Board of Registration in Medicine as an Assistant Attorney General. After having had an opportunity to review Senator Hatch’s substitute bill, we have concluded that the substitution represents, if anything, a greater threat than the original to the effort to improve delivery of palliative care to patients who presently suffer unrelieved pain.

Senator Hatch’s substitute bill doubles the size of the original H.R. 2260 by adding to it some hastily put together jurisdictional and procedural provisions that exacerbate the bill’s potential for frightening physicians into undertreating pain. The most egregious of these provisions is the section dealing with “Burden of Proof.” Whereas the previous bill spoke in terms of disciplining physicians who dispense controlled substances with “the purpose of causing death or assisting another person in causing death,” the new bill states that the Attorney General need only prove that a physician’s intent was to dispense such a substance with “a purpose of causing, or assisting in causing” death. Thus, while purporting to place a heavier burden of proof on the Attorney General (“clear and convincing evidence” rather than “a preponderance of the evidence”), the substitute bill actually lowers the burden of proof. The Attorney General need no longer claim that causing death was the predominant motive in prescribing a controlled substance. She may initiate an investigation and prosecute a physician if she merely suspects that it was among the motives. Perhaps Senator Hatch did not intend to lower the burden of proof in this fashion. But, if so, the fact that the change was made without foreseeing its impact is at the very least evidence of the careless haste with which amendments have been made to this bill in a last-minute effort to save it.

Moreover, raising the standard of proof from “preponderance of the evidence” to “clear and convincing evidence” will not mitigate the deleterious impact of this proposed legislation. Under H.R. 2260, determining whether an act is one of high professional competence, on the one hand, or murder, on the other, hinges upon whether a prosecutor can prove after the fact that the secret intentions of a physician were not merely to suppress pain but also to cause death. This is not the typical case where an accused’s intention is made an element of a crime. In the typical situation, it is clear on the basis of objective fact that a harm has been done and the only question is the degree of responsibility of the actor who has caused the harm. Even in such cases, there is a trend evident in civilized legal systems to move away from dependence upon proof of subjective mental elements. As Judge Posner points out: “[W]e cannot peer into people’s minds, at least not with the clumsy tools of legal procedure, and if we could we are not at all sure that we would find the intentions, malice, premeditation, or other entities that the mentalist language of law invites us to expect.”¹ In 1996, when the Supreme Court of the United States was urged to weigh evidence as to the subjective intentions of police officers in determining whether search and seizure rights of suspects had been violated, that approach was unanimously rejected by the Court. “Subjective intent alone,” said Justice Scalia for the Court, “does not make otherwise lawful conduct illegal or unconstitutional.”²

In *Addington v. Texas* the Supreme Court said of the “clear and convincing evidence” standard: “[T]he ultimate truth as to how the standards of proof affect decisionmaking may well be unknowable, given that factfinding is a process shared by

¹ Richard A. Posner, *The Problems of Jurisprudence* (1977) at 177.

² *Whren v. United States*, 517 U.S. 806, 813 (1996), quoting from *Scott v. United States*, 436 U.S. 128, 138 (1978).

countless thousands of individuals throughout the country. We probably can assume no more than that the difference between a preponderance of the evidence and proof beyond a reasonable doubt probably is better understood than either of them in relation to the intermediate standard of clear and convincing evidence.”³ Whatever difference the higher level of proof might make in other circumstances, it is likely to make very little difference in this context. When we are speaking of physicians’ intentions, we are dealing with an internal mental event that will not, in the ordinary case, be amenable to any sort of objective proof. Although, in the end, the Attorney may have no easier time proving what went on in a physician’s mind than a physician would have disproving it, the fact that H.R. 2260 makes every physician vulnerable to investigation and prosecution whenever he prescribes controlled substances to a dying patient will undoubtedly have a chilling effect on his willingness to effectively treat pain.

Compounding the potential negative impact of this bill is the influence it is likely to have on the behavior of actors other than the Attorney General. Although Senator Hatch’s substitute bill provides that “[n]othing in this subsection shall be construed to alter the roles of the Federal and State governments in regulating the practice of medicine,” this language cannot prevent state actors and private actors from adopting the standards promulgated by the bill for use in other contexts. Once they are employed on a national level as a basis upon which to withdraw DEA licensure, they are likely to be adopted by state boards of registration as standards for disciplining physicians, by district attorneys as standards for determining when to bring prosecutions, and by plaintiffs’ counsel as a basis for making claims for medical malpractice.

Please let us know if we can provide you with any further information.

Respectfully yours,

JAMES VORENBERG,
Roscoe Pound Professor of Law, Harvard Law School.
CHARLES H. BARON,
Professor of Law, Boston College Law School.
GARRICK F. COLE, ESQ.,
Smith & Duggan, LLP.

JOHNS HOPKINS MEDICINE,
DEPARTMENT OF NEUROSURGERY,
Baltimore, MD, February 21, 2000.

DEAR SENATOR: We are opposed to the Pain Relief Promotion Act of 1999 (S. 1272/H.R. 2260) because it will be harmful to patients who suffer from pain. We ask that you oppose the bill and work for legislation that will, indeed, effectively promote pain relief.

As physicians who treat patients regularly for serious pain and other debilitating symptoms, we support urgently needed improvements in pain and symptom management. Based on our experience working with patients and knowing the barriers to effective pain relief, we oppose the Pain Relief Promotion Act as well-intended but against the interests of the millions of Americans who suffer from pain. We urge that you instead support legislation that addresses the real problems in our health care system that block access to high quality pain and symptom management and palliative care.

Our current system already chills effective use of pain medications. Physicians’ fear of investigation, their misunderstandings about opioids because of lack of training, and the tangle of federal and state regulations far too often delay or prevent pain relief that is medically available. The Pain Relief Promotion Act fails to address these issues in a way that will result in positive change.

Amending the Controlled Substances Act to say it is appropriate to use drugs for pain relief even if that use may increase the risk of death is unnecessary. This is already well-established policy at the Drug Enforcement Administration. The bill’s threat of DEA investigators second-guessing a physician’s “intent” in medical decisions, however, will deter many practitioners from aggressive treatment of pain and cause needless suffering by patients.

We urge that you avoid the slippery slope of trying to write standards of medical care into federal statute—especially in the areas of pain and symptom management and palliative care affecting so many older Americans who in most cases are already

³ 441 U.S. 418, 424–425 (1979).

undertreated for pain. What is really needed is for Congress to address the tangle of federal and state requirements and barriers concerning the use of controlled substances that confuse and hamper pain management.

We recommend that Congress hold hearings and develop legislation that would truly address the problems of undertreatment and mistreatment of pain, including initiatives to cover not just pain care at the end-of-life but the very serious public health problem of chronic pain whenever it occurs.

If Congress is serious about promoting good pain management and palliative care, we urge that you oppose the Pain Relief Promotion Act and instead enact provisions that implement a comprehensive approach to pain management and palliative care along the lines, for example, of the Institute of Medicine's report in 1997 on Improving Care at the End of Life.

It would be the utmost of cynicism to turn patients with pain into political pawns by wrapping their medical care into the debate on physician-assisted suicide. For the sake of patients, Congress should not tamper with the Controlled Substances Act. Don't turn the War on Drugs into a War on Patients.

Again, we implore you to reject the Pain Relief Promotion Act and develop a comprehensive approach to pain and symptom management and palliative care that provides real solutions rather than another layer of fear.

Sincerely,

JAMES N. CAMPBELL, MD,
Professor of Neurosurgery and Director of Blaustein Pain Treatment Center, Johns Hopkins Medical Center, Baltimore, MD.

KATHLEEN FOLEY, MD,
Attending Neurologist, Memorial Sloan-Kettering Cancer Center, New York, NY.

NELSON HENDLER, MD, MS,
Founder and Clinical Director, Mensana Clinic, Stevenson, MD.

MARTIN GRABOIS, MD,
Professor and Chairman, Department of Physical Medicine and Rehabilitation, Baylor College of Medicine, Houston, TX.

PAMELA SUTTON, MD,
Director of Palliative Care Services, Broward General Cancer Center, Ft. Lauderdale, FL.

BROWN UNIVERSITY SCHOOL OF MEDICINE,
DEPT. OF MOLECULAR PHARMACOLOGY, PHYSIOLOGY & BIOTECHNOLOGY,
Providence, RI, April 21, 2000.

Senator ORRIN HATCH,
Chairman of the Senate Judiciary Committee, U.S. Senate, Washington, DC.

DEAR SENATOR HATCH: I am writing in the strongest possible terms to endorse your revised version of H.R. 2260, the Pain Relief Promotion Act, scheduled for a committee vote on April 27. Please accept this letter as a written submission for your April 25 hearing on the legislation.

As a medical educator for the past thirty five years, a founding member of the Rhode Island Cancer Pain Initiative, and a founding member of Americans for Integrity in Palliative Care, I respectfully request your support of the revised version of H.R. 2260 entitled the Pain Relief Promotion Act. This enlightened piece of legislation is supported by the American Medical Association, the National Hospice Association, the American Academy of Pain Management, Americans for Integrity in Palliative Care, and Physicians for Compassionate Care.

The passage of the Pain Relief Promotion Act will have an enormous impact on the palliative treatment for the terminally ill. In the last decade, medical care for persons at the end of life and for those who experience severe, chronic pain has evolved dramatically. However, despite the advances of modern day medicine in our country, there is a lack of support and proper treatment of people with terminal illnesses. Even physicians are unaware of and incredulous of the high success rate of recent advances in the appropriate use of pain-relieving drug regimens for the control of chronic, severe pain in terminal patients.

This legislation would provide the necessary resources and educational efforts within both the public and private sectors to intensify the availability of palliative treatment that addresses the physical, psychological, and social distress that accompany terminal illness and intractable pain. The Pain Relief Promotion Act would provide the incentive to correct the following deficits: (1) that most practicing physicians have not been trained in modern day chronic pain management regimens, (2) that most practicing physicians have limited experience in palliative care, and (3) that medical schools do not include formal instruction in palliative care theory and application.

Your support of the Pain Relief Promotion Act will guarantee that patients will receive proper treatment they need in order to face the final stage of their life in dignity and comfort. In the states which have passed laws similar to the Pain Relief Promotion Act, there has been a definite and steady upward trend in the per capital use of morphine for pain relief in palliative care.

I urge you to support and move the Pain Relief Promotion Act—H.R. 2260—as revised to the floor of the Senate for a vote.

Respectfully,

RALPH P. MIECH, M.D., Ph.D.,
Associate Professor (Emeritus).

HUNT VALLEY, MD, *April 20, 2000.*

To: The Senate Judiciary Committee.

From: Robert M. Sparks.

Subject: Comments on Senate Bill 1272.

As a resident of a retirement community for the past fourteen years, I applaud the major objectives of S. 1272. They include: education and training programs for providers in the use of controlled substances in palliative care; development of programs for research and palliative care policy; and provisions for the evaluation of these programs. These are all worthy goals and I believe the 97 per cent of the bill concentrating on them should be passed and funded.

Unfortunately the remainder of the bill, consisting of seven lines (paragraph (2) at the bottom of page 2 of the bill and paragraph (3) at the top of page 3) contribute nothing toward the attainment of the bill's major goals. They merely deny the people of one state the right to make a democratically determined decision, a right which the Supreme Court has ruled, belongs to the states. At least one other state is also considering similar action to afford individuals the right to the kind of life exit they desire. This will would also lay the groundwork for reversing the laws of many states which allow the elderly to make decisions involving the withholding of certain types of treatment to ensure death with dignity.

Although I am currently neutral on the issue of assisted suicide, I urge you to accept the guidance of the Supreme Court on that issue. To do otherwise would open the door to a future possibility that the advance directives I have submitted to the administrators of Broadmead Retirement Community, where I live, could be annulled. These directives are designed to hasten death when I deem it imminent, a condition close to that addressed by the paragraphs cited here, a right provided by the laws of Maryland.

ROBERT M. SPARKS.

STATEMENT OF THE AMERICAN NURSES ASSOCIATION

The American Nurses Association is pleased to have the opportunity to address H.R. 2260, the Pain Relief Promotion Act, which is under consideration by the Committee on the Judiciary. The American Nurses Association is the only full-service professional organization representing the nation's registered nurses through its 53 constituent associations.

ANA has been actively involved in efforts to prohibit assisted suicide and continues to hold a strong commitment to the principle that the role of medical and nursing professionals must be to heal and relieve those in pain but not to act to end a life or to make the means of death available to a person who seeks to end his or her own life.

However, ANA is concerned that provisions of H.R. 2260, even if amended by the proposed substitute to be offered by Senator Hatch, would have a chilling effect on pain management and result in needless suffering, a result that is totally at odds with the professional commitment of the nursing profession. Investigations by the Drug Enforcement Administration, using the ambiguous standard of the intentions

of the health care professionals involved in the prescription of medication, would be intimidating and counterproductive. H.R. 2260, in making effective pain and symptom relief more difficult to obtain, is likely to increase, rather than decrease demands for assisted suicide. Furthermore, it would do nothing to address assisted suicide by means other than controlled substances.

Nurses have long been in the forefront as leaders and advocates for the delivery of dignified and humane end-of-life care and obligated to provide relief of suffering and comfort to a dying person. Participation in assisted suicide is not acceptable under the ethical mandates of the profession, but neither should the legal system erect barriers to appropriate palliative care, which is also an ethical mandate for the profession.

ANA believes the Pain Relief Promotion Act would erect a tragic barrier to appropriate palliative care and is ethically bound to oppose it. ANA appreciates the Committee's consideration of these comments on this issue and urges member of the Committee to oppose this legislation.

Question may be addressed to Stephanie Reed, Associate Director of ANA Government Affairs, 202-651-7088.

PREPARED STATEMENT OF JAMES A. GUEST, EXECUTIVE DIRECTOR, AMERICAN PAIN FOUNDATION

We commend the Judiciary Committee for holding hearings on the Pain Relief Promotion Act (H.R. 2260) and the Hatch Substitute Amendment, and we appreciate Chairman Hatch's attempt to take a bill that we feel will be harmful to effective pain management and make it less harmful. The changes in the Hatch Substitute are in most instances a step in the right direction. But in our opinion both versions of the Pain Relief Promotion Act are seriously flawed, and we oppose H.R. 2260, including the Hatch Substitute, because the legislation is likely to have a chilling impact on effective pain management and does not adequately promote pain relief.

The American Pain Foundation is an independent, nonprofit information, education and advocacy organization serving people with pain. Our mission is to improve the quality of life for people with pain by raising public awareness, providing practical information, promoting research, and advocating to remove barriers and increase access to effective pain management.

The Pain Relief Promotion Act and the Hatch Substitute are, in our view, well-intended but misguided legislation that threatens to hinder rather than help the treatment and care of people who suffer from serious pain, especially near the end of life. The threat of DEA investigators second-guessing their "intent" in medical decisions will most likely deter many physicians and other practitioners from aggressive treatment of pain and cause needless suffering by patients. Ironically, because of the deterrent effect on using opioids, the bill will almost surely increase rather than decrease the incidence of suicide, assisted and otherwise, by those who can no longer tolerate the agony of pain.

We are deeply concerned that if the bill passes physicians will be even more reluctant than they already are to use aggressive medication to treat patients suffering severe pain—even if they judge it to be medically appropriate—and that therefore many more Americans will live and die in pain. We believe the Drug Enforcement Administration should continue to be a law enforcement agency fighting the illegal diversion of drugs. It should not be turned into a medical oversight body—a task for which it is inappropriate and unsuited. Yet this legislation has the potential for just that result.

Pain—A Major Public Health Crisis

The proposed legislation comes at a time when pain is already greatly under-treated because, in part, conscientious physicians and other healthcare professionals fear investigation and sanctions by regulatory bodies for aggressively managing their patients' pain.

Unrelieved pain—cancer pain, non-malignant chronic pain, and acute pain—is a major public health problem in the United States.

- Over 50 million Americans suffer from chronic pain, and each year nearly 25 million people have acute pain as a result of injury or surgery. Yet only 1 in 4 Americans receives proper treatment for their pain.
- Pain costs an estimated \$100 billion each year including medical expenses, lost income, and forced absence from work. Lost workdays resulting from pain add up to over 50 million a year.

- For most types of pain, there are safe, effective treatments available that can alleviate or relieve the pain. According to the federal Agency of Healthcare Research and Quality, for example, 90% of cancer pain can be relieved through relatively simple means. Yet fewer than half of cancer patients receive adequate treatment for their pain.
- In a large survey of oncologists, 86% of respondents felt the majority of patients with pain were undermedicated. Another major national study found that in the their last days of life, more than half of hospitalized patients had unrelieved pain.
- Finally, unrelieved pain is devastating to individuals and families. When serious pain persists it permeates the patient's entire life, making it difficult to concentrate and perform even routine tasks. One of the most common reasons people cite for supporting Dr. Jack Kevorkian's controversial views on physician-assisted suicide is fear of intractable pain. Pain is a major reason patients ask their doctors to help them die.

There is an overwhelming need for Congress to effectively address the public health problem of unrelieved pain. But the Pain Relief Promotion Act, including the Hatch Substitute, does not. It is a bill aimed primarily at physician-assisted suicide, and it does so by using the vehicle of the Controlled Substances Act (CSA) and adding in some modest provisions relating to pain relief. The CSA amendments run the risk of a detrimental effect on the aggressive and medically appropriate use of opioids for pain management while the provisions pertaining directly to pain relief are minimal and inadequate.

A Real Agenda for Pain Relief Promotion

We agree with the broader scope of coverage in the Hatch Substitute so that Title I covers not just "palliative care," which is only one aspect of pain relief, but "pain management" as well. The problem is that the initiatives proposed in H.R. 2260 and the Hatch Substitute are insufficient to make any significant progress in promoting palliative care and pain management.

For example, the bill authorizes only \$5 million for education and training of physicians and other healthcare providers in pain medicine and palliative care—an amount equal to less than 10¢ a person for the over 50 million Americans who suffer from chronic pain—when this need has been consistently cited as badly needed and long overdue. The bill provides no additional funding for research.

Regarding protocols and evidence-based practices, the greater need is not distribution of protocols and practices, although that will be important later on, but support for the medical community to develop more protocols on pain management and palliative care in the first place. The proposed "Decade of Pain Control and Research" is a good idea, and we applaud Senator Hatch for proposing it. But there are no substantive programs attached to this one-sentence declaration of the "Decade of Pain Control and Research," and it needs to be filled in.

We recommend that a true Pain Relief Promotion Act include a number of important initiatives such as the following:

- *Education and Training.* Require that all medical, osteopathic, chiropractic, nursing, physical and rehabilitative medicine, and other professional schools for direct care providers that receive federal funding provide comprehensive education and training in pain management.
- *Fifth Vital Sign.* Require that in all federal healthcare programs (in addition to the Veterans Administration, which has already started doing it) and in programs receiving federal monies, pain must be assessed in all patients as the "fifth vital sign" and be documented in a prominent place in the patient record.
- *Medicare and Medicaid Coverage.* Require that Medicare and Medicaid provide access to and pay for coverage of pain prevention and treatment services and medications used in the management of pain—including removing the Medicare restriction that denies coverage for self-administered pain medication.
- *Patient Self Determination Act.* Amend the Patient Self Determination Act to require that all patients admitted to federally funded health care facilities be informed of their right to adequate pain control.
- *Underserved Populations.* Require that in order for a healthcare organization or provider to receive federal funding or reimbursement of any kind, pain must be adequately assessed and managed in all underserved populations including but not limited to minorities, the young, the elderly and women.
- *Pain Relief Hotlines.* Establish two national toll-free "Pain Relief Hotlines" to answer questions and provide information about pain management—one for medical professionals and one for people with pain and their caregivers.
- *White House Commission.* Establish a White House Commission on Pain Control and Research to increase awareness, understanding and aggressive action to remove barriers and increase access to effective pain management.

- *Center or Advisory Panel at NIH.* Establish a Center for Pain Research at the Institutes of Health (NIH)—or, at a minimum, establish an External Advisory Board on Pain Medicine at NIH, analogous to the External Advisory Board on Cancer.
- *Policy Board at National Institute of Medicine.* Establish a National Pain Management and Palliative Care Policy Board at the National Academies of Science’s Institute of Medicine, analogous to the IOM’s National Cancer Policy Board.
- *Basic and Clinical Research and Outcomes-based Guidelines.* Increase federal funding for basic and clinical research on pain, and appropriate funds for outcome-based research and development of guidelines for treating different kinds of chronic and acute pain and delivery of pain management services.
- *Surgeon General Report.* Require the Surgeon General to prepare and submit a report concerning the state of pain management in the United States to the appropriate committees of Congress and the public.

Flaws in Amending the Controlled Substances Act as a Way To Ban Assisted Suicide and Euthanasia

If Congress wants to pass federal legislation prohibiting physician-assisted suicide, it should pass a separate criminal statute to ban it. We see a number of problems, however, with addressing physician-assisted suicide by tampering with the Controlled Substances Act.

- *Both the original Pain Relief Promotion and the Hatch Substitute will likely cause harm to patients who need pain care by threatening physicians and other healthcare professionals who provide it.* The legislation would give DEA agents the explicit authority—with the urgency of being written into federal statute—to question the intent of any physician or medical practitioner who provided a controlled substance to a patient who died shortly thereafter. A physician could lose the right to practice medicine and be imprisoned for at least 20 years (the same punishment a drug dealer would receive). This would make doctors more hesitant than they already are to prescribe pain-relieving drugs and many more patients would suffer, especially at the end of life.
- *Pain relief therapy should be managed by healthcare professionals—physicians, nurses, and pharmacists—not by federal law enforcement officers.* The Pain Relief Promotion Act and the Hatch Substitute explicitly put the DEA in the middle of critical medical decision-making. They do so by flagging any deaths that follow the prescription of controlled substances. In those cases, the agency may then review the use of pain medications and decide whether a physician’s intentions were to manage pain or hasten death. The very threat of regulatory intervention and oversight—and the fear of having their intentions misconstrued—could dissuade physicians from using aggressive efforts that are often needed to relieve pain effectively.
- *The Pain Relief Promotion Act and its enforcers will not be able to clearly distinguish between legitimate medical use of controlled substances and intentionally causing death.* Drawing the line is not easy for healthcare professionals with years of experience. It certainly will not be easy for law enforcement officers with no medical training. Many patients can tolerate and indeed required extremely high doses of controlled substances to relieve their pain and other symptoms, while the same dose in another patient could be lethal. The line between increasing the risk of death while treating pain (an allowable medical practice) and intentionally causing death (a crime with severe penalties) is a very fine one. Many physicians say they do not trust the DEA to make this distinction and do not feel secure that the DEA will protect them if they aggressively manage pain with opioids.
- *The “double effect” is already protected.* Since at least 1990, the DEA has accepted the “double effect” aspect of pain care—the recognition that aggressive pain relief may have the secondary effect of hastening a patient’s death—although many in the medical community do not realize they are already protected at the federal level. It is not necessary to formalize this policy in statute, and doing so is certainly not worth the price of expanding the DEA’s role into medical oversight and investigation of physicians’ intent. What is needed is not a new law, but better implementation by the DEA of existing policy on “double effect” and better education of physicians and other providers in the use of opioids.
- *By adding even more changes to the Controlled Substances Act than the original bill, the Hatch Substitute may create additional ambiguity.* Raising the burden of proof on the DEA to “clear and convincing evidence” as provided in the Hatch Substitute is an attempt to reassure practitioners, but making a physician’s internal mental intent in prescribing medication subject to external second-guessing by any standard of proof will cause apprehension. Further, while the Hatch Substitute says the bill should not be construed to alter the role of the federal and

state governments in regulating the practice of medicine, it is unclear what those roles currently are so physicians are unlikely to feel reassured. Another section limits certain federal actions but then undoes the limit by adding “except that the Attorney General may take such other actions as may be necessary to enforce this Act.” As more provisions are added to the Controlled Substances Act under the substitute amendment there is more new language requiring interpretation which means there is more potential ambiguity affecting all parties involved.

- *The funding provision in the Hatch Amendment suggests a new enforcement function for the DEA despite statements by the bill’s supporters that no new authority or medical oversight is intended in the 49 states other than Oregon.* The provision refers to a new section (relating to a practitioner’s “intent” and “purpose,” and Oregon-type laws) as being “added by this Act” and earmarks funds for “carrying out” the section. This appears to indicate that a new function or standard would be applied to DEA activities under the Diversion Control Program—a function or standard needing funding—and that certainly would have a chilling effect on pain management. As with other provisions, it is unclear how the DEA in the future may interpret and implement the proposed section.
- *The Controlled Substances Act is an inappropriate and ineffective vehicle for addressing the issue of assisted suicide.* For one thing, prohibiting just healthcare providers registered under the CSA but not others from assisting in suicide—and prohibiting only those assisted suicides in which controlled substances are used—is a very narrow and ineffective way to ban the practice. This proposed law would not stop the Dr. Kevorkians of the world because they are not registered and do not use controlled substances. Moreover, by threatening good pain management the new law could have the intended impact of driving even more people to seek suicide, assisted or otherwise, because they cannot get relief from their excruciating pain.

Separate Issues Calling for Separate Legislation

There are two big, highly complex issues involved in H.R. 2260: (1) physician-assisted suicide, and (2) the need for better pain management. Each issues raises important unanswered questions and deserves full and poverty consideration in its own right. Assisted suicide goes far beyond the use of controlled substances. And relieving pain goes far beyond the DEA.

Assisted suicide should be dealt with in a separate law, not linked to the medical practice of pain management. We urge that you address each of these two issues separately—not linking them together—and that you act on each issue on its own merits. Potentially serious and far-reaching changes in the treatment of pain should not occur simply as the by-product of a bill on assisted suicide.

We urge the Members of the Judiciary Committee not to risk causing more pain for people who have already suffered enough by passing the Pain Relief Promotion Act when there are better ways to ban assisted suicide and better ways to promote pain relief. Don’t turn patients with pain into political pawns by wrapping their medical care into the debate on physician-assisted suicide. Don’t risk turning the “War on Drugs” into a “War on Patients.” Don’t pass the misnamed and misguided Pain Relief Promotion Act.

PREPARED STATEMENT OF JOSEPH J. FINS, M.D., F.A.C.P.

Mr. Chairman, Senator Kennedy and distinguished members of the Committee. Thank you for this invitation to testify regarding the Pain Relief Promotion Act of 1999. I appreciate this opportunity to comment on the important legislation and initiative to improve end-of-life care and pain management.

By the way of background, I am a member of the faculty at Weill Medical College of Cornell, Director of Medical Ethics at the Cornell Campus of New York Presbyterian Hospital in New York City, Associate for Medicine at the Hastings Center and a Project on Death in America Faculty Scholar of the Open Society Institute.¹ My academic, research and clinical work is in medical ethics, the care of the dying, and educational efforts to improve training in palliative care for medical students and resident physicians.^{2 3 4 5 6} I was privileged to serve on the New York State Attorney General’s Commission on Quality Care at the End-of-life convened by former Attorney General Dennis C. Vacco after he represented New State before the Supreme Court in the physician-assisted suicide case, *Quill v. Vacco*.⁷

As a practicing internist who has cared for dying patients as well as a medical ethicist who consults regularly on end of life care issues in a major academic med-

Footnotes at end.

ical center, I am deeply concerned about the quality of care that is provided to dying patients and their families. I know first hand that care is often lacking because clinicians are inadequately trained in pain and symptom management or because of an often pervasive avoidance of issues surrounding death, dying and mortality.⁸

For these reasons I am especially gratified that this bill is being debated and these hearings have been convened. I believe that we as a nation can and must do a better job of making life's final passage more humane and compassionate.

Having said this, I am not convinced that Senate Bill 1272 will have its desired effect of improving the care of dying patients and easing the burden imposed by inadequate pain and symptom management. I am deeply concerned that the proposed provision to ensure the legitimate use of controlled substances by "enforcement actions by law enforcement personnel" to "accommodate such use" will have a chilling effect on pain management in the clinical setting. This provision will complicate an already tenuous situation with respect to pain management, which this legislation is trying to ameliorate.

As the Committee certainly appreciates, the academic literature in medicine and medical ethics amply demonstrates that pain is under recognized and under treated at the end of life.⁹ Upwards of 50% of Americans die in moderate to severe pain.¹⁰ This is especially tragic because the technology and pharmacology exists to ensure that dying patients die comfortably.^{11 12}

The reasons for the under-use of pain medications are multi-factorial. They include scientifically unfounded concerns about addiction, restrictive drug laws, cultural and attitudinal barriers and regulatory impediments that impede access to controlled substances.^{13 14 15} These factors lead to a burden of treatable distress for patients that are ethically unacceptable.

Furthermore, at the end of life, some clinicians are reluctant to use sufficient dosages of opioids to relieve pain because they fear that this may hasten death and that the clinically appropriate use of pain medications could be confused with physician-assisted suicide. Widely endorsed ethical norms in medical practice from a range of clinical societies and a recent decision of the U.S. Supreme Court unequivocally affirm the physician's obligation to relieve pain even if doing so may hasten an inevitable death.¹⁶ Ethicists often invoke the doctrine of double effect to distinguish interventions to relieve suffering that may hasten death from physician-assisted suicide or euthanasia when death is intended.¹⁷

Organized medicine, especially the American Board of Internal Medicine and the American Medical Association has made great progress in getting the message out that the use of opioids in pursuit of pain—even if their use hastens an expected death—does not constitute physician-assisted suicide.^{18 19}

In this evolving environment, the enforcement provision could erode this progress. Because the ethical doctrine of double effect hinges on the sometimes ambiguous question of the intent of the physician when prescribing the medication, many physicians will opt to avoid this gray zone and not prescribe needed medication to dying patients.

One could well envision a physician's concern when prescribing opioids for a dying patient with cancer who had been treated with pain medications for months before death. Given the pharmacology of opioids and the development of tolerance the patient requires higher dosages of medication over time for an adequate analgesic effect. When the patient dies she will be on a large but clinically appropriate dose of medication. Will physicians be comfortable escalating doses of opioids to adequately treat their patients when they also are worrying about whether a law enforcement agent will appreciate that such drug escalation in a function of pharmacology and disease progression? Who will assure the concerned practitioner that an over zealous prosecutor will not mistake appropriate clinical conduct as physician-assisted suicide? Such investigations have already occurred to the detriment of appropriate end of life care and pain management.^{20 21 22}

Given these concerns, the enforcement provision could have the unintended effect of leading physicians to be even more hesitant to prescribe opioids out of fear that their use will trigger an investigation. Although the intention of the bill is otherwise, this provision would have the dire de facto effect of criminalizing the use of opioids at the end of life. This would be a tragedy for dying patients and their families who would have to watch them suffer.

As a physician, it seems inappropriate to me that medical practice should be dictated by the fear of a regulatory agency and not by professional and scientific norms. The enforcement provision seems intrusive and a breach of the therapeutic relationship that must exist between patient and physician. In an era when legislators from both parties bemoan the intrusion of managed care bureaucrats in the doctor-patient relationship,²³ the insertion of drug enforcement personnel at the bedside of dying patients seems especially egregious.

From a policy standpoint, these developments would be an unfortunate reversal of progress that has been made in medical education altering physician perceptions about the use of opioids. It will reverse the progress that has been made over the past ten years to educate physicians about the proper use of these medications. This legislation could further exacerbate the under-use of opioids and dramatically undermine the care of the dying.

As I understand this legislation, one of its intended goals is to promote pain management and palliative care without sanctioning or permitting physician-assisted suicide or euthanasia. I have written about the ethics of physician-assisted suicide.^{24 25 26} Beyond this theoretical examination of this issue, I have expressed my belief that the legalization of physician-assisted suicide would be bad public policy and not meet the needs of dying patients and their families. I have advanced this argument during the judicial proceedings leading up to the Supreme Court's decision as well as in the context of the debate surrounding Oregon's Proposition 16 which ultimately legalized physician-assisted suicide in the state.^{27 28}

It is important to appreciate that I am against the enforcement provision and remain opposed to physician-assisted suicide. I do not oppose this legislation because I am in favor of physician-assisted suicide. Although I respect the democratic process that lead to the passage of their law, I oppose the developments in Oregon. My opposition to this Act stems from my belief that its passage would undermine end of life care and leave a terrible legacy of pain and distress in its wake.

Finally, it is ironic that the enforcement provision would be advanced in light of the work of the 1997 report of the Institute of Medicine examining the care of the dying. This distinguished panel made wide ranging recommendations for improvement of the status quo by addressing professional competence, pain and symptom management, health care financing of palliative care, reform of restrictive drug prescription laws, medical education, research in end-of-life care and encouraging a public dialogue about our societal obligations to the dying and their families.²⁹ It is important to note that among their recommendations was the easing of restrictive prescription laws, not increased regulatory review as would follow from the passage of the Pain Relief Promotion Act of 1999.

For these reasons, I think the better course of action would be to adopt the provisions advanced by Senator Wyden in Senate Bill 941. This legislation is consistent with the scholarly and thoughtful recommendations of the Institute of Medicine Report and leaves the care of dying patients to their doctors, not law enforcement agents. That is how each of you will want it if you or a loved one was dying and in pain.

Mr. Chairman, thank you for this opportunity to testify before your Committee and to comment on this important issue.

FOOTNOTES

¹The views and opinions expressed in this testimony are my own and not necessarily those of any of the organizations with which I am affiliated.

²Miller FG and Fins JJ. A Proposal to Restructure Hospital Care for Dying Patients. *New England Journal of Medicine* 1996;334:1740-1742.

³Fins JJ, Miller FG, Acres CA, Bacchetta MD, Huzzard LL, and Rapkin BD. End-of-Life Decision-Making in the Hospital: Current Practices and Future Prospects *Journal of Pain and Symptom Management* 1999;17(1):6-15.

⁴Fins JJ. Case Study Commentary: Resuscitation in Hospice. *The Hastings Center Report* 1998;28(6):21-22.

⁵Fins JJ, Professionalism and Pain Management. *Journal of Pain and Symptom Management*. In Press.

⁶Fins JJ. Acts of Omission and Commission in Pain Management: The Ethics of Naloxone Use. *Journal of Pain and Symptom Management* 1999;17(2):120-124.

⁷Attorney General Dennis C. Vacco's Commission on Quality Care at the End of Life. *Final Report*. New York. July 1998.

⁸Fins JJ Death and Dying in the 1990's: Intimations of Reality and Immortality. *Generations: Journal of the American Society on Aging* 1999;23(1):81-86.

⁹Cleeland CS, Gonin R, Hatfield AK, et al: Pain and its Treatment in Outpatients with Metastatic Cancer. *N Engl J Med* 1994;330:592-596.

¹⁰SUPPORT Principal Investigators. A controlled trial to improve care for seriously ill hospitalized patients: The Study to Understand Prognoses and Preferences for Outcomes and Risks and Treatments (SUPPORT). *JAMA* 1995;274:1591-1598.

¹¹World Health Organization. *Cancer Pain Relief and Palliative Care*. Geneva: WHO, 1996.

¹²Hanks G and Cherny N. Opioid analgesic therapy. In, *Oxford Textbook of Palliative Medicine*, 2nd Edition. Doyle D, Hanks GWC, and MacDonald N, editors. New York: Oxford University Press, 1998 pp. 331–355.

¹³Hill CS Jr. The Barriers to Adequate Pain Management with Opioid Analgesics *Semin Oncol* 1993; 20(suppl 1): 1–5.

¹⁴Reidenberg MM. Barriers to Controlling Pain in Patients with Cancer *Lancet* 1996;347(9011):1278.

¹⁵Fins JJ. Public Attitudes about Pain and Analgesics: Clinical Implications *Journal of Pain and Symptom Management* 1997;13(3):169–171.

¹⁶Burt RA. The Supreme Court Speaks—Not Assisted Suicide but a Constitutional Right to Palliative Care *N Engl J Med* 1997;337:1234–6.

¹⁷Beauchamp TL, Childress, JF. *Principles of Biomedical Ethics*, 4th ed. New York: Oxford University Press, 1994. pp. 206–211.

¹⁸American Board of Internal Medicine. *Caring for the Dying: Identification and Promotion of Physician Competency*. Philadelphia. ABIM. 1996.

¹⁹American Medical Association. EPEC Project—Education for Physicians on End-of-Life Care. Chicago. American Medical Association. 1998

²⁰Stern Hyman C. State Medical Boards and Pain Management *Journal of Pain and Symptom Management* 1998;15:379–81.

²¹Virginia Board of Medicine against William E. Hurwitz.

²²Hoover v. Agency for Health Care Administration. 676 So. 2d 1380 (Fla. Dist. Ct. App. 1996).

²³Fins JJ. Challenges to the Doctor-Patient Relationship in Managed Care: A Tale of Two Prescriptions. *Seminars in Medical Practice* 1998;1(1):22–26.

²⁴Fins JJ and Bacchetta MD. Physician Assisted Suicide and Euthanasia Debate: An Annotated Bibliography of Representative Articles. *The Journal of Clinical Ethics* 1994;5(4):329–340.

²⁵Fins JJ and Bacchetta MD. Framing the Physician-Assisted Suicide and Voluntary Active Euthanasia Debate: The Role of Deontology, Consequentialism, and Clinical Pragmatism *Journal of the American Geriatrics Society* 1995;43(5):563–568.

²⁶Fins JJ and Viederman M. Case Study Commentary: But is it Assisted Suicide? *The Hastings Center Report* 1995;25(3):272–25.

²⁷Fins JJ. Physician Assisted Suicide and the Right to Care. *Cancer Control: Journal of the Moffitt Cancer Center* 1996;3(3):272–278

²⁸Fins JJ. What Medicine and the Law should do for the Physician-Assisted Suicide Debate. *CCAR Journal Spring* 1997;46–53.

²⁹Committee on Care at the End of Life, Field MJ and Cassel CK, editors *Approaching Death: Improving Care at the End of Life*. Washington, D.C. Institute of Medicine-National Academy Press. 1997.

PREPARED STATEMENT OF SCOTT M. FISHMAN, M.D.

My name is Scott Fishman and I am Chief of the Division of Pain Medicine and Associate Professor of Anesthesiology at The University of California, Davis School of Medicine. I specialize in Pain Medicine, have board certification in Pain Medicine, Internal Medicine, and Psychiatry, and my life work has been the treatment of suffering and improvement of quality of life. I oversee a large office and hospital-based program for pain management in adults and children with acute or chronic pain or pain related to terminal illness. I have recently authored a book title *The War on Pain* for the general consumer audience and I have published professional works in the medical literature on topics related to pain management.

I have reviewed the “Hatch substitute” to H.R. 2260 and am opposed to it. But I am also firmly opposed to physician-assisted suicide. Advancements in Pain Medicine have made the notion of hastening death for patients who are in too much pain unnecessary.

It is because aggressive pain management can be so effective for patients in serious pain, especially near the end of life, that I oppose the current “Hatch substitute” bill as well as the earlier version of the Pain Relief Promotion Act. Either version of the bill will limit our ability as physicians to effectively treat pain, progressing in treating pain and suffering has come, in large part, through decreasing the barriers for appropriate use of our strongest pain relievers, the opioid narcotics. The threat of potential punishment for aggressive pain management misconstrued as physician-assisted suicide will increase a prominent barrier to pain relief. The “Hatch substitute” will send a chilling message to those who use narcotic medications in the treatment of pain. The possibility of having one’s actions misinterpreted with extremely harsh consequences will almost certainly make most physicians think twice before ordering a strong narcotic pain reliever, and many will unfortu-

nately opt to ignore the patients' pain. While this may seem like a rash conclusion, it is what we have seen throughout our own medical history as well as in our present state of healthcare. At present, although pain is treatable in the vast majority of cases, it is treated effectively in only the minority of cases. Even children with terminal illnesses are still under-treated for their suffering. Subtle barriers to prescribing narcotics still impede good pain management and the subtle, yet clear message of greater scrutiny over narcotic prescribing will only further increase reluctance to treat pain.

No matter how many strong appeals are made for good pain management, how many resources are offered to advance knowledge, or how high the bar is set on proving intent in physician-assisted suicide, physicians are human, and I believe that human nature will respond to the looming threat of serious punishment. In my opinion, those few, well intentioned but ill-advised physicians who see physician-assisted suicide as a viable option will not be readily identified while the rest of us, who are able to make physician-assisted suicide unnecessary with good pain medicine, will be undermined. It is ironic that the "Hatch substitute", which seeks to prevent physician-assisted suicide, will ultimately impair one of the truly effective counters to physician-assisted suicide, which is swift and effective pain medicine. Thus, the "Hatch substitute" will neither bring about what it seeks to accomplish, nor prevent what it seeks to block.

PREPARED STATEMENT OF DAVID E. JORANSON

My name is David E. Joranson. I am a Senior Scientist and Director of the Pain & Policy Studies Group, University of Wisconsin Comprehensive Cancer Center, Madison. I thank the Committee on Health, Education, Labor and Pensions for the opportunity to address the Committee.

I applaud the Committee for taking an interest in what you can do to improve pain management and end of life care in the United States; this is of course the ultimate matter of quality of life for us all. I encourage the Committee to take time to develop a full perspective on the human, medical, social and policy aspects, to become familiar with the unique barriers, assess what is already being done, and then consider the options. I can contribute to one part of your picture; my area of knowledge is controlled substances policy and the regulation of medical practice in relation to pain management.¹

The Committee has before it two pieces of legislation to improve pain management: One is S. 941, to amend the Public Health Service Act, the other is S. 1272, to amend the Controlled Substances Act (CSA). My comments will focus on the risks that should be considered before amending the CSA as has been proposed.

It is important to realize that the CSA has a dual purpose relating to both drug abuse prevention and also to recognizing and preserving the important medical uses of many controlled substances. Indeed, achieving a 'balanced' drug control policy is an obligation of governments which is established by the United Nations Single Convention on Narcotic Drugs, 1961, i.e., to prevent the misuse of drugs without interfering with their medical use, in particular for the relief of pain and suffering. The CSA was structured by the Congress to achieve a balance between these two purposes. When controlled substances policy loses its balance the chances increase for there to be conflict between law enforcement and medicine, with resulting harm to pain management and patient care.

The CSA is a law enforcement statute aimed at preventing abuse of controlled substances, and for these purposes it is administered by the Attorney General (AG). The CSA also recognizes that many controlled substances (such as opioid analgesics) are necessary to maintain public health, and that they must be available to meet legitimate medical and scientific needs.

¹My knowledge and experience with controlled substances law goes back about thirty years, to the vigorous debate and final adoption in 1970 of the CSA. In addition I have had the following relevant experiences: administrative officer for the State of Wisconsin's Controlled Substances Board; worked with Congressional subcommittees to successfully adopt amendments to the CSA in 1984 to strengthen DEA's program against diversion of controlled substances; co-founded the National Association of State Controlled Substances Authorities and the first State Cancer Pain Initiative, which became a World Health Organization Demonstration Project; conducted research on Federal and state controlled substances laws and state professional practice laws and regulations; served for several years on the drafting committee of the National Conference of Commissioners on Uniform State Laws to revise the Uniform Controlled Substances Act for the States; assisted in the development of state medical board guidelines for the use of controlled substances in the treatment of pain; worked with the National Conference of State Legislatures to develop informational materials for state legislatures.

In order to achieve this balance, the Congress spelled out several fundamental principles which recognize that certain functions are to be carried out under jurisdictions other than federal drug law enforcement in the Department of Justice. These three areas are: (1) the medical and scientific decisions necessary to administer the CSA, (2) the recognition of the medical uses of drugs, and (3) the recognition of the role of State laws, especially those regulating medical practice.

(1) *Medical and scientific decisions.* The Congress decided in 1970 that medical and scientific decisions, such as the evaluation of the potential for abuse of drugs being placed in the five schedules of the CSA, are the responsibility of the Secretary of the Department of Health and Human Services (DHHS), not the AG (See Section 811.(b) of the CSA). The principle of "balance," was established in the course of vigorous and extended debate over a Department of Justice bill that, as proposed, would have given the AG exclusive power to make decisions of a medical and scientific nature.² Congress appropriately rejected this approach and assigned this authority to the DHHS. Medical and scientific organizations were actively involved to ensure that the CSA was balanced in this respect, and this policy has endured to this day, including amendments to the CSA which were adopted in 1984 to increase DEA's capability to revoke practitioner registrations in the public interest.

(2) *Relation of the CSA to the Federal Food, Drug and Cosmetic Act.* The Congress determined a second fundamental principle, that the CSA is not to "be construed as in any way affecting . . . the provisions of the Federal Food, Drug and Cosmetic Act" (see Section 902). It is extremely important to recognize that it is under authority of the FFDC, not the CSA, that drugs are approved as safe and effective for medical use, so that they can be marketed lawfully in interstate commerce. In addition, federal administrative law and court decisions have made it clear that although the Food and Drug Administration (FDA) approves drugs for marketing, it does not regulate medical practice, which is left to the States. Many opioid analgesics have been approved for treatment of pain, and also for diarrhea, and cough. The fact that opioids (and many other drugs approved for human use under the FFDC) are also controlled substances under the CSA is not intended to affect their status as drugs which are safe and effective and may be prescribed by physicians. Indeed, the difference between legal and illegal drugs in the schedules of the CSA is defined by whether a drug is approved under the FFDC as having an accepted medical use.

(3) *Relation of the CSA to State laws.* The third principle reflects the fundamental relation between the federal government and the States. The CSA is not intended to occupy areas of State laws which are within the authority of the States:

No provision of this subchapter shall be construed as indicating an intent on the part of the Congress to occupy the field in which that provision operates, including criminal penalties, to the exclusion of any State law on the same subject matter which would otherwise be within the authority of the State, unless there is a positive conflict between that provision of this subchapter and that State law so that the two cannot consistently stand together. (CSA, Section 903)

It would be extraordinary to invoke the federal CSA to contravene the policy of a single state, or to use the CSA to establish medical and scientific policy with respect to drugs.

Mr. Chairman, against the context of the foregoing fundamental principles which limit the scope of the CSA, I offer a few concluding observations:

(1) *Opioid analgesics are already legal.* This is determined under the FFDC. To define or comment on the medical uses in a federal drug law enforcement statute ignores one of the fundamental principles of balance.

(2) *The DEA has already said that they understand that opioid analgesics are needed for chronic pain.* A 1974 DEA regulation made it perfectly clear that nothing in the CSA precludes practitioners from providing opioids for intractable pain.³ DEA reemphasized this point again in its 1990 Physicians Manual, encouraging physicians to prescribe opioids when they are needed:⁴

Controlled substances and, in particular, narcotic analgesics, may be used in the treatment of pain experienced by a patient with a terminal illness or chronic disorder. These drugs have a legitimate clinical use and the phy-

²"Controlled Dangerous Substances, Narcotic and Drug Control Laws" Hearings before the U.S. House of Representatives Committee on Ways and Means. Washington, DC: U.S. Government Printing Office, 1970.

³Code of Federal Regulations Part 21, Section 1306.07(c)

⁴Drug Enforcement Administration. Physician's Manual: An Informational Outline of the Controlled Substances Act of 1970. U.S. Department of Justice: DEA; March, 1990.

sician should not hesitate to prescribe, dispense or administer them when they are indicated for a legitimate medical purpose. It is the position of the Drug Enforcement Administration that these controlled substances should be prescribed, dispensed or administered when there is a legitimate medical need. (DEA, 1990, p. 21).

Indeed, DEA representatives are to be commended for their willingness to clarify federal policy in relation to medical practice; they have spoken at numerous pain conferences around the U.S. The DEA, and major medical organizations, have endorsed a new Model Guideline⁵ on the use of controlled substances for pain.

(3) *New DEA regulations?* S. 1272 contemplates that the AG/DEA may promulgate “regulations to implement this Act.” Is it appropriate to give DEA rule-making authority in this sensitive area? How will the agency distinguish between pain management and assisted suicide? Apart from the inherent difficulty in determining a physician’s intention, a recent review supported the notion that opioids hasten death is more myth than fact.⁶ Given that H.R. 2260 allows for DEA regulations in connection with new language about pain, hastening death and assisted suicide, it seems likely that the Attorney General and the DEA would be faced with decisions which involve medicine and science, conflicting with the first fundamental principle.

(4) *The potential for a chilling effect.* I will close with the following point. I assume that this Committee fully accepts that pain is not adequately managed in this country, and that this is due, in part, to the under-use of opioid analgesics, especially, but not only, for people at the end of life. One of the reasons is that while many physicians still do not have sufficient knowledge about pain management, they also fear being investigated if they prescribe ‘too much.’ the origin of these fears goes back many years, and are in part an unintended effect of the war on drugs. The solution to this problem requires that we give greater attention to achieving a balanced controlled substances policy which clearly recognizes that controlled substances have important medical uses, and that we communicate it so that it is understood by regulators and practitioners. The amendments to the CSA which have been proposed threaten to upset the balance that the Congress has established, and which many of us have been working to achieve.

PREPARED STATEMENT OF NATIONAL ASSOCIATION OF PRO-LIFE NURSES

The National Association of Pro-life Nurses strongly supports the Pain Relief Promotion Act (HR 2260) and we urge you to vote for its passage to help insure adequate pain relief for our patients.

The National Association of Pro-life Nurses is a non-profit organization with several hundred members engaged in our profession. Our members live and work in some 46 states of the United States of America. We are united by a shared dedication to the ideals of our caring and ministering profession; the promotion of health, the alleviation of suffering, and the respect for and preservation of human life.

Double Effect

This bill provides an important tool to be used in administering adequate pain relief while it prohibits the use of controlled substances for the purpose of causing death. With HR 2260, a doctor cannot be held responsible for the death of a patient receiving large doses of these potentially lethal substances if the intention is to relieve the pain of the suffering patient, not to end his or her life. Our members have no problem with administering dosages of medication for pain relief beyond what would normally be considered “safe” doses when the patient is suffering excruciating pain. But we do object to the use of any substance which may have this double effect when the intent is to cause the death of the patient. We are morally opposed to any measures taken to hasten or cause the death of any person and what this practice to remain outside the acceptable practice of medicine.

Promotion of Better Pain Relief

This bill removes a barrier that has impeded good pain control in the past, namely the fear of doctors that they will be accused of euthanasia for aggressively treating the excessive pain experienced by some patients. We are assured that they will be able to administer whatever dosage it takes to achieve adequate pain relief. We

⁵Federation of State Medical Boards of the United States, Inc. Model Guidelines for the Use of Controlled Substances for the Treatment of Pain. Euless, TX; May 1998.

⁶Fohr SA. The double effect of pain medication: Separating myth from reality. *Journal of Palliative Medicine.* 1998; 1(4):315–328.

note the absence of empowerment to seek out physicians who use more than average doses of medication than their fellow practitioners, and the prohibition of non-medical persons from being the arbiters in what constitutes good pain management. This is especially reassuring to those in fields such as oncology where patients often need much larger doses of medication for satisfactory pain control. We are pleased to find that the concerns of many medical groups, initially hesitant to support the bill, have had these concerns satisfactorily addressed, and most are now in support of the bill.

Research/Education

The provisions in the bill for more research in palliative care and better education of health care professionals in pain relief is, from our nursing perspective, most welcome and something long overdue. Treatment of pain comprises a good portion of what many of us in the medical profession are called to do, yet the time spent in training in this area does not reflect the time consumed in the actual practice of medicine. Research in this area has never been as extensive as that of seeking other medical advances, even though many of the new technologies developed are an even greater source of pain and discomfort. This provision is warmly welcomed by our members.

Many of us in the nursing profession can cite examples of patients in extreme and seemingly intractable pain for whom greatly increased doses of medication are ordered. These doses are often determined to be lethal for a non-suffering person, yet the suffering patient experiences little suppression of his or her vital signs as a result. It requires a person trained and skilled in the detection and treatment of such pain to be effective in relieving it.

“Chilling Effect”

Returning to the promotion of better pain relief in this bill, I would refer you to the studies to which you have access in great detail in other testimony. They are studies done in several states in which assisted suicide is banned by law. The studies indicate a far greater use of the classic pain control drug, morphine sulfate, which is a Class A controlled narcotic, in those states after this law has been passed. When assisted suicide is prohibited by law, greater steps are taken to relieve the pain of suffering patients so that they are not driven to request such a drastic measure as taking their life. And certainly any remaining fear of the “chilling effect”, as claimed by some of the opponents of the bill, would be further removed by the research and education provisions.

Patient Advocates

Although the provisions of this bill are directed at the physician as the prescriber of the medication, our contact with the patient is often closer and more personal than that of the physician. Therefore, the concerns of this bill have perhaps a greater impact on our day to day experiences than that of the physician. We are the ones caring for the patient after the physician departs, left to deal with the torment of excruciating pain suffered by one in our charge. Knowing that the physician cannot be held responsible for the death of the patient gives us more incentive to help the physician to be more aggressive in the treatment of pain.

Conscientious Objection

The last consideration is for us as nurses. We are charged with carrying out the orders of the physician who has the ultimate care of the patient. Our existence as an organization is based on a need to affirm to nurses that they have rights, too, and one of those rights is the right to refuse to participate in practices which offend our conscience. All of our members are committed to respect for life from conception to *natural death*. That does not include death by medication. This is not only a problem for us as individuals who are charged with the execution of the doctors orders, but for the medical profession which must then deal with how to address this concern when those charged with carrying out the orders are unable to comply. As more and more situations arise where we are being asked to compromise our moral beliefs, it becomes very difficult for nurses to perform their duties. Consequently, it is difficult for administration to deal with this problem. Nursing has always been and, because of its service nature, will always be, comprised primarily of individuals of altruistic motivation who will rise to the defense of the vulnerable and defenseless. Not asking us to perform these tasks in the first place, as this bill would do, goes a long way toward keeping some of the most compassionate and caring members of the nursing profession at the bedside of the suffering.

—Respectfully submitted by Marianne Linane, Executive Director, National Association of Pro-life Nurses.

PREPARED STATEMENT OF THE NATIONAL CONFERENCE OF CATHOLIC BISHOPS

The Catholic bishops of the United States strongly support the Pain Relief Promotion Act of 1999 (H.R. 2260), as well as the substitute bill proposed by chairman Orrin Hatch which incorporates revisions requested by medical organization (henceforth "Chairman's Substitute"). We believe that swift enactment of this legislation is needed for two purposes: (1) to correct a seriously flawed 1998 ruling by U.S. Attorney General Janet Reno, which authorizes the use of federally regulated drugs to assist vulnerable patients' suicides wherever the practice is permitted by state law; and (2) to promote the legitimate use of these drugs to relieve pain and other distressing symptoms, especially for patients who are terminally ill.

In our view, these two goals are both important, and are closely related. Terminally ill patients deserve better pain control precisely because they have the same innate worth and dignity as all other human beings and are in special need of our love and support. When a society singles out these patients as candidates for physician-assisted suicide, it denies the value of their very lives, and thereby undermines respect for their dignity and their legitimate needs—including their need for the best possible palliative care.

When we accept assisted suicide as a "good enough" solution for these patients, we preach a counsel of despair to all terminally ill patients. We tell them that we find it easier to kill them than to find ways to kill their pain. By rejecting the "quick fix" of assisted suicide, however, we reaffirm to ourselves and to the medical profession that these patients have lives worth living, and that they deserve real solutions for the pain, depression and isolation that they may experience.

In our view, then, the two titles of this bill—one providing federal support for training in palliative care, the other clarifying federal law on the use of controlled substances—serve the same goal of promoting genuine supportive care for some of our most vulnerable citizens. Because medical professionals can speak with greater expertise on the palliative care provisions in Title I of the Chairman's Substitute, we would like to focus on the urgent need to enact Title II, clarifying the Controlled Substances Act.

The Need to clarify the Controlled Substances Act

On June 5, 1998, contradicting an earlier determination by her own Drug Enforcement Administration, U.S. Attorney General Janet Reno ruled that the State of Oregon, by rescinding its own penalties for assisting the suicides of certain patients, had effectively succeed in unilaterally amending federal drug laws as well. According to the Attorney General, Oregon's law had established assisted suicide as a "legitimate medical practice" within Oregon's borders—and the federal government lacked any basis for disagreeing with this judgment. Under this ruling, however, federal intervention by the Drug Enforcement Administration (DEA) "may well be warranted" in other states—and is warranted even in Oregon, when a physician "fails to comply with state procedures" regarding how and when to assist suicides. Federal law will protect the lives only of those still deemed by the state to deserve suicide prevention, instead of suicide assistance.

Thus Attorney General Reno's ruling requires the federal government to ratify Oregon's assisted suicide policy—and to help implement it, by licensing physicians to prescribe and distribute federally regulated drugs for the required lethal overdoses. This is not only morally wrong—it directly contradicts everything that Congress and federal agencies have ever said about terminally ill patients and assisted suicide:

—Current federal policy demands an increased penalty when the victim of a federal crime is seriously ill or otherwise "unusually vulnerable."¹ Yet in Oregon, it is now the U.S. Justice Department's policy that the serious illness of the victim transforms a crime into a "legitimate" medical procedure, so that it is no crime or offense at all. Oregon's discriminatory policy, which stigmatizes an entire class of patients and denies them the equal protection of the law, has effectively been ratified by federal administrative fiat.²

¹United States Sentencing Commission, Guidelines Manual, p. 227, §3A1.1.

²The Oregon law has been found to violate constitutional guarantees of equal protection by the only federal court to review that law on the merits. See *Lee v. Oregon*, 891 F. Supp. 1429 (D. Or. 1995), *vacated on other grounds*, 107 F.3d 1382 (9th Cir. 1997), cert. denied, 522 U.S. 927 (1997). In its 1997 rulings on assisted suicide, the U.S. Supreme Court noted that it has yet to review the validity of this argument: "Lee, of course, is not before us . . . and we offer no opinion as to the validity of the Lee courts' reasoning. In *Vacco v. Quill* . . . , however, decided today, we hold that New York's assisted suicide *ban* does *not* violate the Equal Protection Clause." *Washington v. Glucksberg*, 521 U.S. 702, 709 n. 7 (1997) (emphasis added). To this day no appellate court has ruled on the constitutionality of law like Oregon's.

—As the U.S. Supreme Court noted in its 1997 rulings on assisted suicide, it is a longstanding policy under the federal drug laws “to protect the terminally ill, no less than other patients,” from potentially lethal drugs.³ Yet in Oregon this policy is now turned on its head, so that federal prescribing licenses are used precisely for the purpose of facilitating lethal overdoses for the terminally ill.

—In 1997, Congress almost unanimously approved the Assisted Suicide Funding Restriction Act (42 U.S.C. § 14401 et seq.) to ensure that federal funds, health facilities and health programs are not used for assisted suicide or euthanasia. The Senate approved this legislation 99-to-0. Signing it into law, President Clinton said it “will allow the Federal Government to speak with a clear voice in opposing these practices”; and he warned that “to endorse assisted suicide would set us on a disturbing and perhaps dangerous path.” Yet an important federal statutory scheme, designed to ensure that potentially dangerous drugs are used only to promote patients’ health, is now being used to condone and facilitate assisted suicide.

The Attorney General’s ruling is especially indefensible as an interpretation of the Controlled Substances Act (CSA). Nothing in that Act indicates that an individual state, by dropping its own state penalties for a form of manslaughter, can convert such killing into a “legitimate medical purpose” for the use of federally controlled drugs within the meaning of the federal Act. Indeed, any “states’ rights” argument on this issue is contradicted by the plain language and intent of the CSA. Provisions to ensure that narcotics and other dangerous drugs are used solely for a “legitimate medical purpose” (21 C.F.R. § 1306.04), and are never used to endanger “public health and safety” (21 U.S.C. § 823(b)(5)), have been included in this Act and its implementing regulation precisely to establish a uniform federal standard that would not rely on the vagaries of individual state laws.⁴

A clear and explicit purpose of such provisions was to prevent the use of federally regulated drugs for lethal overdoses, not only their use for addiction. Obviously, using drugs to cause people’s deaths is an even greater threat to health and safety than using them to feed an addiction.

Current enforcement of the CSA reflects this understanding. In the past, physicians have had their DEA registrations revoked for giving dangerous drugs to patients who then used them to commit suicide (see, e.g., the case of Dr. Hugh Schade, reported at 60 Fed. Reg. 56354 [Nov. 8, 1995]). Practitioners can lose their registrations in such cases even for negligently giving these drugs to patients who they should have known might use them for suicide.⁵

Such enforcement has often relied on the separate federal policy of protecting patients’ health and safety, quite aside from whether a practitioner has violated state criminal laws or even state medical licensing standards. Especially since the CSA was clarified and strengthened in 1984, “state licensure is a necessary but not sufficient condition for DEA registration” (63 Fed. Reg. 8479 [Feb. 19, 1998]). By the same token, revoking a DEA registration does not imply that a physician will lose his or her state medical license or has violated state law.⁶ The Chairman’s Substitute for H.R. 2260 makes explicit the States’ sole authority to govern state medical licensing and state prescribing privileges.

To reaffirm this longstanding and consistent federal policy that all citizens, including the terminally ill, deserve protection from the lethal misuse of potentially dangerous drugs, new legislation is needed and long overdue.

Choosing the Means: New Features of H.R. 2260

In 1998 legislation was introduced to correct the Attorney General’s legal error. The Lethal Drug Abuse Prevention Act (H.R. 4006, S. 2151) was approved by House

³Washington v. Glucksberg, 521 U.S. 702, 729 (1997), quoting United States v. Rutherford, 442 U.S. 544, 558 (1979).

⁴In particular, 1984 amendments to the CSA were designed “to make it easier for the [DEA] to suspend or revoke the authority of physicians . . . who write or dispense prescriptions in a way that is threatening to the public health or safety,” even in cases where they may not have been charged or convicted under state criminal statutes. Remarks of Rep. Gilman, 130 Cong. Rec. H9681 (daily ed. Sept. 18, 1984), quoted in *Trawick V. Drug Enforcement Administration*, 861 F.2d 72, 75 n. * (4th Cir. 1988).

⁵Thus H.R. 2260’s affirmation that the relevant section of the CSA does not authorize intentionally prescribing and dispensing federally regulated drugs for the purpose of causing death is restrained, and carefully focused on the legal anomaly created by the Attorney General’s ruling.

⁶“Registration of a physician under the Controlled Substances Act is a matter entirely separate from a physician’s State license to practice medicine. Therefore, revocation of registration only precludes a physician from dispensing substances controlled under the Controlled Substances Act and does not preclude his dispensing other prescription drugs or his continued practice of medicine.” S. Rep. No. 225, 98th Congress, 2d Sess., reprinted in 1984 U.S. Code Cong. & Admin. News 3182, 3449 n. 40.

and Senate Judiciary Committees, but was opposed by many medical groups who claimed it would have an adverse effect on physicians' ability or willingness to prescribe controlled substances for pain relief. This year's Pain Relief Promotion Act addresses these concerns in the following ways:

1. In order to correct the anomaly the Attorney General has created in the way federal law is enforced in Oregon, last year's legislation established a new substantive policy against the use of controlled substances for assisted suicide throughout the 50 states. Critics feared that this explicit new authority might be taken as giving the DEA a new mandate to question and scrutinize physicians' medical decisions in order to detect assisted suicides.⁷ H.R. 2260 is based on a recognition that no new authority of this kind is needed. The Attorney General herself has acknowledged that the DEA already has authority to prevent the misuse of controlled substances for assisted suicide in every state except Oregon (and even has that authority in Oregon, when an assisted suicide does not comply with all the state's guidelines). The only new explicit statement on this issue in H.R. 2260 is that a state, by enacting a law permitting assisted suicide, does not succeed in changing the separate federal standard that already applies to all other states—in other words, a law like Oregon's has no "force and effect" in determining whether a practitioner has violated separate federal standards for protecting patients' health and safety. This simply reaffirms what is already true under the federal Supremacy Clause: Where state and federal law conflict, federal law governs. The Chairman's Substitute also adds explicit statements that this bill cannot be construed to alter the respective roles of state and federal governments in regulating medical practice or to authorize new national standards for clinical practice regarding pain management.

2. The 1998 bill gave priority to stating a new policy against assisted suicide, then explained that this policy does not forbid the legitimate use of controlled substances to control pain. In H.R. 2260 the emphasis is reversed: It contains a forthright and explicit declaration on the legitimacy of using controlled substances to control pain, then adds that this and other policy statements in the relevant section of the CSA do not authorize the use of controlled substances for assisted suicide. In several ways the Chairman's Substitute further emphasizes the bill's strong commitment to promoting pain management and palliative care: It adds a "findings and purpose" section on this subject, reverses the order of the bill's titles to give greater prominence to the palliative care provisions, and adds a provision calling for a new decade of commitment to pain management.

3. H.R. 2260 contains a new mandate that the DEA's continuing education programs for federal, state and local law enforcement personnel include education in how their enforcement procedures can better accommodate the legitimate medical use of controlled substances for pain relief. Combined with the provisions supporting education and training in palliative care for health professionals, this provision underscores the federal policy that pain control is an important and legitimate purpose for the use of federally regulated drugs—a policy that has never before been so explicitly stated in federal statutes. The Chairman's Substitute amends the provision on continuing education for law enforcement personnel to make it unambiguously clear that these personnel are to be trained in giving greater deference to physicians' decisions in the field of pain medicine—not in making medical determinations themselves.

The Pain Relief Promotion Act is carefully tailored to clarify federal law on assisted suicide only to the minimum degree needed to correct the Attorney General's ruling, so that the federal government will no longer actively facilitate assisted suicide in any state that has legalized the practice. It does not give new enforcement authority to the DEA, and does not change the law at all in the vast majority of states—except to give new emphasis to the legitimate use of federally regulated drugs to control pain, and to provide a clearer "safe harbor" from legal liability for health professionals committed to such use.

Killing Pain vs. Killing Patients

Because the relationship between optimal pain management and physician-assisted suicide is central to this legislative debate, the difference—we would say, the contradiction—between the two practices is worth further comment.

The medical profession has long recognized that efforts to control pain using powerful drugs may sometimes have side-effects. Very rarely, controlling pain in dying

⁷ Indeed, the bill's creation of a new medical advisory board to review particular cases was taken by critics as evidence that massive new enforcement actions were contemplated—though sponsors intended this board as an independent panel of experts to be convened only at the practitioner's request, to provide an additional shield against medically uninformed enforcement actions.

patients may require the use of such large doses of drugs that the patient's breathing reflex may be suppressed and the dying process hastened. The physician's intent in these cases, however, is to use the minimum dosage needed to control the pain; any risk of hastening death is not intended, but is foreseen as the unavoidable side-effect of a legitimate medical action.⁸

This principle of double effect is not especially obscure. The difference between consequences which are intended, and those which are only foreseen, is part of everyday life. As one federal appellate judge has observed, when General Eisenhower gave the order for D-Day he knew many American soldiers would die as a result—but that does not mean he murdered them.⁹ Conversely, when King David ordered Uriah the Hittite to the front line of battle, then called back his other men so Uriah would be killed, he murdered him as surely as if he had wielded the weapon himself (2 Sam 11:15–17).

The important factor here is the agent's intent—what am I trying to achieve by this action? The goal of pain control is a patient who is relieved of pain. The goal of assisted suicide is a world that is relieved of one more patient. And this difference of purpose is reflected in the different ways drugs are used in the two practices. Pain control requires carefully titrating drugs to the point where pain is relieved with a minimum of side-effects; assisted suicide generally requires one sudden and massive dose of drugs, to make sure that the patient does not have time to build up any resistance to the drugs' lethal effects.

The euthanasia movement has tried to obscure this difference for its own narrow purposes. Jack Kevorkian claimed in his assisted suicide and murder trials that he was only trying to end "suffering," though the means he used had no analgesic properties. Assisted suicide supporters filed many briefs with the U.S. Supreme Court two years ago, claiming that pain control and assisted suicide were practically indistinguishable. They lost this debate. As the Supreme Court has said:

[A] physician who withdraws, or honors a patient's refusal to begin, life-sustaining medical treatment purposefully intends, or may so intend, only to respect his patient's wishes and "to cease doing useless and futile or degrading things to the patient when [the patient] no longer stands to benefit from them." Assisted Suicide in the United States, Hearing before the Subcommittee on the Constitution of the House Committee on the Judiciary, 104th Cong., 2d Sess., 368 (1996) (testimony of Dr. Leon R. Kass). The same is true when a doctor provides aggressive palliative care; in some cases, painkilling drugs may hasten a patient's death, but the physician's purpose and intent is, or may be, only to ease his patient's pain. A doctor who assists a suicide, however, "must, necessarily and indubitably, intend primarily that the patient be made dead." *Id.*, at 367. Similarly, a patient who commits suicide with a doctor's aid necessarily has the specific intent to end his or her own life, while a patient who refuses or discontinues treatment might not

Logic and contemporary practice support New York's judgment that the two acts are different, and New York may therefore, consistent with the Constitution, treat them differently.¹⁰

Since November 1994, when Oregon first approved its law allowing physician-assisted suicide, all other states discussing the issue have reaffirmed this distinction. No state has followed Oregon's lead; several have passed new laws against assisted suicide, including provisions to emphasize the distinction between assisted suicide and pain control.¹¹

⁸Such effects are far rarer than was once thought. "No more than 1 per cent of patients who receive narcotics for pain develop serious respiratory depression." M. Angell, "The Quality of Mercy," in 306 *New England Journal of Medicine* 99 (January 14, 1982). "There is close to universal ethical approval of the bold use of pain-control measures even if their use risks decreasing the period of survival. Yet palliative-care experience shows this situation to be extremely rare. The drugs for pain relief are very safe. Palliative-medicine specialists do not agree that good pain relief shortens life. Pain relief without sedation is a central and achievable goal of palliative care." J. Scott, "Fear and False Promises: The Challenge of Pain in the Terminally Ill," in I. Gentles (ed.), *Euthanasia and Assisted Suicide: The Current Debate* (Stoddart: Toronto 1995) at 100.

⁹See *Compassion in Dying v. Washington*, 79 F.3d 790, 856 (9th Cir. 1996)(Kleinfeld, J., dissenting), rev'd, 521 U.S. 702 (1997).

¹⁰*Vacco v. Quill*, 521 U.S. 793, 801–02, 808 (1997).

¹¹Since 1994 new statutes against assisted suicide have been enacted in: Louisiana (1995); Rhode Island and Iowa (1996); Virginia, Michigan and South Carolina (1998); and Maryland (1999). Between 1997 and 1998, three states (Kansas, Oklahoma and South Dakota) added to their existing criminal prohibitions by providing civil penalties as well. The Michigan law did not include an explicit disclaimer on the legitimacy of pain control, but such legislation was later

What has happened to pain control in states enacting new bans, and in states that have rejected proposals to legalize assisted suicide? Time after time, actions to ban assisted suicide or to reaffirm existing bans have been followed by advances and improvements in pain control:

—When Rhode Island considered a new ban on assisted suicide in 1996, the state medical society objected that such a ban would have an adverse effect on physicians' willingness to use drugs like morphine for aggressive pain control.¹² But in fact, the opposite happened. In the year following enactment of the ban, according to official figures from the DEA, Rhode Island more than doubled its per capita use of morphine for pain control, rising from 46th among the states to 19th in morphine use. To this day Rhode Island's use of morphine is twice what it was before its ban was enacted. A similar, though less startling, improvement was seen in Iowa after its ban was enacted the same year. In fact, none of the states passing new bans on assisted suicide since 1994 have seen declines in morphine use, and several have seen dramatic improvements.

—The year after President Clinton signed the Assisted Suicide Funding Restriction Act, banning assisted suicide in all federal health facilities, advocates for palliative care reported that the Veterans Administration health care system had "made improving the quality of its end-of-life care a top priority" and implemented many positive changes in this field.¹³

—After a legalization measure was defeated by popular referendum in 1991, the Washington State Medical Association issued its first handbook ever for rank-and-file physicians on palliative care for dying patients. California's 1992 debate on a legalization measure, also defeated by popular vote, was the catalyst for a 1994 "Summit on Effective Pain Management" convened by the governor's office, which led to new policy changes to facilitate the prescribing of controlled substances for pain control (e.g., a new 1998 law ending the practice of triplicate prescription forms). Similarly, after Michigan enacted its ban on assisted suicide in 1998 it proceeded to enact several new laws to encourage physicians to practice effective pain control.

There is ample evidence for the observation, made by the American Medical Association and dozens of other medical groups in their 1997 Supreme Court brief in *Quill*, that "the prohibition on physician-assisted suicide provides health care professionals with a tremendous incentive to improve and expand the availability of palliative care."¹⁴

By the same token, as the National Hospice Organization noted in its brief in the same case, "the acceptance of assisted suicide as a way to deal with terminal illness would undercut further efforts to increase the public's awareness of hospice as a life-affirming option."¹⁵ As Supreme Court Justice Breyer noted during oral argument in these cases, we have certainly seen this in the Netherlands, where hospice care is woefully underdeveloped: that country, which permits assisted suicide, had only three palliative care centers, compared with 185 in England which prohibits assisted suicide.¹⁶

Some may claim that Oregon is an exception to this rule, that legalization has actually led to great improvements in hospice and palliative care. But those claims are misleading and exaggerated, for the following reasons:

—Oregon was a leader in palliative care long before legalization, and almost all the alleged improvements took place before the new law took effect in the fall of 1997. Many of these improvements were made by Catholic and other organizations seeking to ensure that patients would not be railroaded into assisted suicide once the objectionable law took effect.

—Many similar improvements have occurred in states which have passed new bans on the practice, or simply debated and then defeated legalization measures. It is the debate itself that often focuses lawmakers' and physicians' attention on the need to improve palliative care.

—Whatever brief incentive this debate may have created for improving care of the dying in Oregon now seems to be giving way to a more ominous trend. The state

enacted separately; Jack Kevorkian's flagrant but effective misuse of the "principle of double effect" in his trials made Michigan legislators hesitant to include such language in their ban.

¹² Assisted suicide to be R.I. felony," *American Medical News*, Aug. 12, 1996 at 31.

¹³ S. Beckwith, "VA Makes Better End-of-Life Care a Top Priority," *Last Acts Newsletter*, Summer 1998 at 6.

¹⁴ Brief for Amicus American Medical Association, et al., at 22, *Vacco v. Quill*, 521 U.S. 793 (1997) (No. 95-1858).

¹⁵ Brief for Amicus National Hospice Organization at 18, *Vacco v. Quill*, 521 U.S. 793 (1997) (No. 95-1858) and *Washington v. Glucksberg*, 521 U.S. 702 (1997) (No. 96-110).

¹⁶ Oral Arguments in *Vacco v. Quill*, reprinted in 12 *Issues in Law & Medicine* 417, 437 (Spring 1997).

of Oregon has begun to provide public funding for assisted suicide, while cutting back on access to some pain control drugs and other treatments for terminally ill patients; the same trend has been observed among private health insurers in the state.¹⁷

—The DEA’s figures on per capita use of morphine may be instructive in this regard. Oregon has always ranked among the top states in such use, coming in 3rd in 1992 (two years before its legalization proposals was first approved). It rose to 2nd place in 1996, when the measure was still enjoined and assisted suicide was still illegal. But in both 1997 and 1998, Oregon was in 6th place—outpaced in morphine use by five states that have not legalized assisted suicide.¹⁸ In 1999 Oregon was again in second place—with first place going to New Hampshire, a state that explicitly bans assisted suicide and has recently once again defeated a legalization measure. These data do not provide any clear support for the claim that legalizing assisted suicide encourages the use of drugs for pain control; they certainly disprove the claim that prohibiting assisted suicide discourages pain control.

Conclusion

H.R. 2260 supports and promotes palliative care as an integral part of good health care. It also helps *prevent* federal support for a practice that is ultimately the enemy of good palliative care—the deliberate use of medications to pervert the goals of medicine and intentionally help cause patients’ deaths. For both these reasons it deserves support and swift enactment.

Fact sheets submitted as attachments to testimony:

1. Oregon’s Ranking Among States in Per Capita Morphine Use
2. Legislative History of Federal Drug Law Supports Authority to Act Against Physician-Assisted Suicide
3. Past Cases Show DEA Authority to Act Against Assisted Suicide

Oregon’s Ranking Among States in Per Capita Morphine Use

The facts do not support a claim that legalization of physician-assisted suicide has made Oregon a leader in use of pain medication. Its ranking among states in per capita use of morphine was higher in 1992, two years *before* legalization, than in some years following legalization.

- 1992—3rd highest use in the nation
- 1993—10th
- 1994—11th (year of the campaign to pass assisted suicide measure)
- 1995—3rd (measure approved but enjoined by court)
- 1996—2nd
- 1997—6th (law takes actual effect in November 1997)
- 1998—6th
- 1999—2nd

These figures do not show that the morphine is used for—that is, whether all of it is used in Oregon for pain control or some for deliberate assisted suicides. Despite this fact, in 1997 and 1998 Oregon was outpaced in per capita morphine use by five states that have not legalized assisted suicide. Three of these ban it by statute (New Hampshire, Missouri and Arizona). One state (Vermont) bans assisted suicide by common law, and one (Nevada) has no clear law on assisted suicide.

For 1999 the ranking of the states with no clear law on assisted suicide is: Nevada—4th; Wyoming—38th; Utah—44th; Hawaii—51st.

New Hampshire, which ranks first among states in morphine use for 1999, has repeatedly debated and rejected legalization measures in recent years, most recently by Senate vote in February 2000.

In 1996, Iowa and Rhode Island passed new bans on assisted suicide. Both states experienced significant *increases* in morphine use in the months following enactment. Rhode Island more than doubled its rate of morphine use in one year; such use remains about twice what it was the year before the ban was enacted.

—Sources: Drug Enforcement Administration (for morphine data); Americans United for Life (for survey of state law)

¹⁷D. Gianelli, “Suicide opponents rip Oregon Medicaid’s pain control policy,” *American Medical News*, Sept. 28, 1998 at 7; S. Rojas-Burke, “Health Plan cuts threaten status of safety-net clinics,” *The Oregonian*, Feb. 16, 1999; J. Hamby, “The Enemy Within,” *The Oregonian*, Jan 21, 1998.

¹⁸These states prohibits assisted suicide by statute (Missouri, New Hampshire, Arizona) or by common law (Vermont). The sole exception is Nevada, which has no clear law on the matter. In 1998 the DEA rankings on morphine use for the other states without a clear law were 40th (Wyoming), 48th (Utah), and 50th (Hawaii).

LEGISLATIVE HISTORY OF FEDERAL DRUG LAW SUPPORTS AUTHORITY TO ACT
AGAINST PHYSICIAN-ASSISTED SUICIDE.

The Controlled Substances Act of 1970 was amended in 1984 to strengthen the Drug Enforcement Administration's ability to prevent diversion of federally regulated prescription drugs for illicit purposes. The amendments were approved by the U.S. Senate 91-to-1 on February 2, 1984 as part of a Comprehensive Crime Control Act (S. 1762). Almost identical language was approved by the House 392-to-1 as a free-standing "Dangerous Drug Diversion Control Act of 1984" (H.R. 5656) on September 18, 1984. The House and Senate versions were reconciled and ultimately approved as part of H.J. Res. 648, a continuing resolution which became law on October 12, 1984 (P.L. 98-473).

This legislative background helps answer some questions raised about the federal government's authority to apply this federal law against physicians who prescribe controlled substances to assist suicides:

Was the federal law directed primarily against street drugs like heroin and cocaine?

No, the 1984 amendments were directed specifically against the misuse or "diversion" of federally regulated prescription drugs which have a legitimate medical use. The prime House sponsor said this had become a more serious problem in some ways than street drugs but had "failed to get the societal or the enforcement attention that it deserves" (Rep. Hughes, Cong. Record, 9/18/84, H9679).

Was the law directed against physicians?

Yes, though not exclusively. "The bill gives to DEA greater latitude to suspend or revoke the registration of a practitioner who dispenses drugs in a manner that threatens the public health and safety" (Id.). As the chairman of the House Commerce Subcommittee on Health and the Environment said at the subcommittee hearing on this bill: "Today's pusher is not always a back alley salesman. He or she may well be a highly educated health professional" (Rep. Waxman, Hearing of July 31, 1984, Hearing Record No. 98-168, p. 365). There were also provisions directed at manufacturers and pharmacists.

Was the law directed against addiction, or against the use of drugs to cause death?

The chief concern cited was their potential to cause physical harm and death. Sponsors cited a government study indicating that "prescription drugs are responsible for close to 70 percent of the deaths and injuries due to drug abuse" (Rep. Hughes, Cong. Record, 9/18/84, H9679). The chairman of the Health subcommittee in the House agreed: "Drugs legally manufactured for use in medicine are responsible for a substantial majority of drug-related deaths and injuries" (Rep. Waxman, Hearing Record No. 98-168, op. cit., p. 365). One sponsor used the example of an opiate widely used as a pain-killer, saying: "Because these pills have an even greater potential for physical injury and damage, they involve more than half of the hospital entries for illegal use and overdose of drugs" (Rep. Sawyer, Cong. Record, 9/18/84, H9680).

Was the law designed to defer to states' judgments on the proper medical use of drugs?

On the contrary: It was designed to give the DEA more independent authority to revoke a physician's registration in cases where a state *refused* to intervene. The 1984 amendments authorized the DEA to revoke a physician's registration if it deems that registration to be "inconsistent with the public interest" (in cases where, for example, revoking registration will serve "public health and safety"). As Rep. Charles Rangel said in support of the amendments: "Under current law, the DEA must register physicians, pharmacies, or other practitioners if they are authorized to dispense drugs by the law of the State in which they practice. . . . The public interest standard added by H.R. 5656 will provide greater flexibility to deny or revoke registrations in the most egregious cases" (Cong. Record, 9/18/84, H9682). (When a law is enacted to prevent prescription drugs from being used for lethal overdoses, there is nothing more egregious than a physician who *intentionally* dispenses drugs for such overdoses.) Prime Senate sponsor Strom Thurmond spoke similarly, saying that this provision "expands the standards for practitioner registration beyond the current exclusive reliance upon authorization by the practitioner's own jurisdiction" (Cong. Record, 2/2/84, S758). Sponsors said giving such flexibility to the federal government was necessary because states often did not respond adequately to these abuses: "State policing of these activities, as well as peer review within the profession, have not been adequate control measures. State laws regarding the dispensing of controlled substances are also inadequate" (Rep. Fish, Cong. Record, 9/18/84, H9680). At a hearing before the House Subcommittee on

Health and the Environment, the DEA called the expanded federal authority to revoke practitioner registration “one of the most important sections of the bill,” not only because states were often ill-equipped to enforce their own drug laws but also because “many controlled drug violations involving prescription drugs are not felonies under state law and therefore cannot be used in a DEA revocation action” under then-existing law (Testimony of Gene R. Haislip, Deputy Assistant Administrator, Drug Enforcement Administration, Hearing Record No. 98-168, p. 404). Congress’s view was that while the states are the first line of defense against misuse of prescription drugs, the federal government must enforce its own objective standard as to what constitutes such misuse—and it must have the authority to enforce that standard when a state cannot or will not do so.

In light of this history, it cannot be maintained that the Controlled Substances Act as it exists today was directed only against professional drug traffickers rather than physicians, or only against addition rather than lethal drug overdoses, or only against physicians who violate state laws. Independent federal authority to enforce federal drug standards was intended to apply to “Schedule II” prescription drugs like barbiturates or morphine as much as to “Schedule I” drugs like marijuana or cocaine—most especially when such drugs are being used to cause death.

PAST CASES SHOW DEA AUTHORITY TO ACT AGAINST ASSISTED SUICIDE

Currently, practitioners run afoul of the federal Controlled Substances Act if their actions cause or contribute to the use of federally regulated drugs for fatal or near-fatal overdoses. In one recent case, a doctor was denied a DEA registration because he gave potentially lethal drugs to a depressed patient who he should have known might well use them for suicide. The following list of cases from the Federal Register is far from exhaustive:

1. *60 FR 56354 (Nov. 8, 1995): Case of Dr. Hugh Schade*: The doctor was negligent because he gave potentially lethal amounts of Darvocet to a depressed patient who used them to commit suicide. Giving these drugs to a patient in this mental state, said one expert witness, was “like handing him a loaded gun.” While Dr. Schade was also convicted of negligent homicide under state law because of this case, his DEA application was denied not on the basis that he had violated a state law [21 USC § 823(f)(3)], but on the separate basis that his conduct objectively threatened “public health and safety” [21 USC § 823(f)(5)].

2. *62 FR 16189 (April 4, 1997): Case of Dr. Jose R. Castro*: Here a patient died of a drug overdose using controlled substances which the doctor prescribed “for no legitimate medical reason.” The doctor had lost his state license to prescribe controlled substances on this basis, so it was automatic that he lost his federal registration as well; there was no need to apply the “public health and safety” standard independently.

3. *49 FR 6577 (February 22, 1984): Case of Dr. Samuel Fertig*: A physician was denied a DEA registration because he had prescribed massive quantities of controlled substances to several young people who used them in lethal overdoses. Acknowledging that the physician had been restored to full medical licensure in his state, the DEA Administrator nonetheless ruled that the physician “was responsible, directly or indirectly, for the deaths of several young people” (49 FR at 6579) and hence that the application must be denied to protect “public health and safety.”

4. *63 FR 8477 (February 19, 1998): Case of Townwood Pharmacy*: A woman reported to the DEA that her daughter, who had a drug problem, had overdosed several times using drugs from this pharmacy. From the notice it is clear that if this was proved, it would have counted against the pharmacy under the “public health and safety” standard; but there was no clear evidence that the woman obtained the drugs from this pharmacy. The pharmacy’s registration was revoked on other grounds.

5. *55 FR 5306 (Feb. 14, 1990): Case of Dr. Murray J. Walker, Jr.*: This physician prescribed Percodan for non-medical purposes to several people; one woman died of a drug overdose. Her boyfriend then cooperated with investigators because he believed the physician “was responsible for the woman’s death” (55 FR at 5306). In revoking the physician’s registration the DEA noted: “Substances are controlled because they are potentially dangerous and therefore should be handled with extreme care. Respondent has failed to exercise such care and, as a result, has ignored his duties as a health care professional to protect the public health and safety from the illicit use of these drugs” (Id. at 5307).

6. *55 FR 4250 (February 7, 1990): Case of Dr. Rodrigo I. Ramirez*: While conducting an unauthorized treatment program for drug addicts, this physician issued a prescription for large quantities of Dolophine and Xanax to a patient who died

the next day from an overdose. The Oklahoma Medical Board suspended his state registration to prescribe certain controlled substances, but later reinstated him under supervision. The DEA concluded that he had “prescribed controlled substances without medical need and in excess of the amount considered good medical practice” (55 FR at 4252). Despite the physician’s argument that he had been sufficiently punished under state law, the DEA revoked his federal registration, saying: “The Administrator cannot and will not in all cases rely on state authorities to monitor and regulate a registrant holding a DEA controlled substances registration where there is evidence that the registrant has violated Federal law and has demonstrated conduct which may further threaten the public health and safety” (Id. at 4252).

7. *45 FR 61047 (September 15, 1980): Case of Dr. Joyce E. Millette:* This physician supplied controlled substances to many drug addicts, including one man who used the drugs in a lethal overdose and a young man who was rendered unconscious by an overdose. The second young man’s father, a dentist, testified that the physician “had prescribed drugs without adequate knowledge of the condition or medical background of the patient, in strengths and amounts which could have brought about dependency and possible death” (45 FR at 61048). At least two other potentially fatal drug overdoses were attributable to drugs the physician had prescribed. The DEA noted: “A DEA registration carries with it enormous potential for harm. Controlled substances, properly administered or prescribed, may be very useful in the course of medical treatment. Improperly used, they have the potential for dependency, addiction and even death” (Id. at 61048). Revoking the physician’s registration, the DEA noted that “several overdose incidents and at least one death were attributable to the controlled substances she prescribed. The Administrator finds it hard to conceive of a more compelling case for revoking a registration or denying an application” (Id. at 61049). The Administrator also expressed regret that the law at that time did not allow for effective DEA action prior to a physician’s “prosecution and conviction” under state law, noting: “In a case such as this, such a procedure might conceivably have saved lives” (Id. at 61049). [Four years later the DEA received such authority from Congress to revoke registrations independently of whether state law had been violated.]

8. *51 FR 5422 (February 13, 1986): Case of Dr. Rex A. Pittenger:* This physician “prescribed numerous controlled substances for no apparent legitimate medical reason.” After one patient died of a drug overdose, he was convicted of involuntary manslaughter and other felonies in one state and lost his medical license in another; on these grounds both his DEA registrations were revoked.

9. *48 FR 49937 (October 28, 1983); 54 FR 53382 (December 28, 1989); 59 FR 6297 (February 10, 1994): Case of Dr. David W. Bradway:* This physician’s registration was revoked after he was convicted under state law on various counts, most notably “one count of manslaughter by unlawfully distributing controlled substances in such a grossly negligent [and] reckless manner as to cause the death of an individual” (48 FR at 49937). Years later, after allegedly rehabilitating and resuming medical practice, the physician applied for a new DEA registration; citing the fact that “a death was directly attributable to Respondent’s misuse of his DEA Certificate of Registration,” the DEA denied the application, stating: “it is the position of the DEA that a Certificate of Registration to handle controlled substances is a privilege, not a right, and it should only be granted to doctors who have demonstrated high standards of ethical conduct and who are completely trustworthy in handling dangerous controlled substances which, as can be seen in this case, can have a devastating impact on individuals who abuse them” (54 FR at 53384). In 1992, again applying for a DEA registration, the physician “testified with great sincerity and obvious pain concerning the remorse and regret that he felt about the events leading to the individual’s death” and submitted a psychiatric report and further evidence of rehabilitation (59 FR at 6298). However, due to “the egregious nature of Respondent’s past conduct,” the DEA ruled in 1994 (15 years after the patient’s death) that “the registration of the Respondent is still not in the public interest” (Id. at 6299).

10. *55 FR 37579 (September 12, 1990): Case of Dr. Pompeyo Q. Braga Bonado:* The DEA found that granting a registration to this physician would be “clearly contrary to the public interest.” 55 FR at 37580. The physician had prescribed controlled substances to several individuals “for no legitimate medical purpose,” including one man addicted to Percocet who was hospitalized after a suicide attempt. “As a health care professional and DEA registrant,” the DEA noted, “Respondent bears a heavy responsibility to ensure that the controlled substances he prescribes are not abused.” Id. at 37580.

11. *59 FR 46063 (September 6, 1994): Case of Dr. John W. Copeland:* This physician’s registration was revoked because he had prescribed Ritalin and other drugs to many addicted persons without a legitimate medical need. One patient ob-

tained anabolic steroids from the physician after revealing that he had taken them in the past, was depressed and had attempted suicide ten months earlier, a medical expert testified that it is “medically dangerous” to give anabolic steroids to a patient with prior depression. The DEA found that the physician’s continued registration was contrary to the public interest, in part because his actions endangered public health and safety.

Several of these cases illustrate two points. First, in judging whether continuing a registration will serve the “public interest,” the DEA may assess whether the registrant’s practice threatens “public health or safety” independently of whether he or she can be shown to have violated state law. Second, while the absence of a state license automatically means that the federal government will issue no license, the converse is not true—that is, “state licensure is a necessary but not sufficient condition for DEA registration” (63 FR at 8479 [Feb. 19, 1998]). Under current law, DEA registration requirements do not depend solely upon the policies of individual states.

—R. Doerflinger, 4/20/00.

PREPARED STATEMENT OF THE NATIONAL RIGHT TO LIFE COMMITTEE

The National Right to Life Committee strongly supports passage of the Pain Relief Promotion Act, a bill to ban the use of federally controlled drugs to kill patients.

This bill would most appropriately show that the federal government favors helping vulnerable people, not having them kill themselves. The National Right to Life Committee believes that you do not solve problems by getting rid of the people to whom the problems belong.

The pro-suicide movement talks about autonomy. Years of experience in the Netherlands and now the writing from the US euthanasia movement show that assisted suicide and euthanasia are about anything but autonomy. Assisted suicide is about getting rid of people who are inconvenient or costly. Even when no outside pressure is put on people who are very sick or disabled, the legalization of assisted suicide carries with it an implicit burden, creating a feeling of guilt on those who feel they are imposing on their loved ones. Assisted suicide is the ultimate abandonment.

People who are ill need our compassion and care. Laws against assisted suicide provide a safety net for people who are potential victims of greedy insurance companies, weary families or simply their own depression that prevents them from seeing the value of their lives. Depression can be treated, pain can be controlled, and many organizations and support groups are ready to help patients and their families through difficult times. It is tragic that the people in Oregon who were killed with the assistance of their doctors, with the permission of their state, and with federal drugs, will never have the benefit of those life-affirming alternatives.

The Attorney General, Janet Reno, was wrong in overriding federal drug law in order to provide access to narcotics and dangerous drugs to doctors who want to help kill their patients. We are so grateful that the House of Representatives has acted to reverse that ruling and now the Senate stands poised to do the same. We applaud the Members of both Houses who view assisted suicide as desertion and who are working to provide even better access and education in the area of pain control.

The compassionate answer to people who are ill is to expand the safety net of care and protection and to extend more emotional and psychological support. The answer of Derek Humphry and other suicide proponents is to discard those who don’t meet some arbitrary standard of worth or who are deemed “too burdensome.”

PREPARED STATEMENT BY THE ONCOLOGY NURSING SOCIETY

The Oncology Nursing Society (ONS) is the largest oncology group in the United States composed of over 29,000 nurses dedicated to improving the care of oncology patients and oncology health services. ONS has serious concerns and reservations about The Pain Relief Promotion Act in that it could inadvertently harm patients with cancer who have severe pain and require supportive care.

Many patients with cancer require extremely large doses of pain medications to assure that they are comfortable and can maintain a good quality of life and interaction with their family. These seemingly large doses are not prescribed to assist in a suicide but to assure good pain control and quality cancer care. ONS does not endorse the practice of physician assisted suicide.

ONS has following concerns regarding The Pain Relief Promotion Act:

- The legislation would give Drug Enforcement Administration (DEA) agents the explicit authority to question the intent of any physician or medical practitioner who provided a controlled substance to a patient who died shortly thereafter. The

line between increasing the risk of death while treating pain (an allowable medical practice) and intentionally causing death (a crime with severe penalties) is a very fine one. To have the DEA make this distinction may harm pain management.

- Since at least 1990, the DEA has accepted the “double effect” aspect of pain care—the recognition that aggressive pain relief may have the secondary effect of hastening a patient’s death. Therefore, it is not necessary to formalize this policy in statute, and doing so is certainly not worth the price of expanding the DEA’s role. What is needed is not a new law, but better implementation by the DEA of existing policy on “double effect” and better education of physicians and other providers in the use of opioids.
- Raising the burden of proof on the DEA to “clear and convincing evidence” as provided in the Hatch Substitute is an attempt to reassure practitioners, but making a physician’s internal mental intent in prescribing medication subject to external second-guessing by any standard of proof could be chilling.
- As more provisions are added to the Controlled Substances Act under the substitute amendment, there is more potential for ambiguity affecting all parties involved.

More training for physicians and other healthcare providers is needed. The bill authorizes only \$5 million for this—less than \$0.10 a person for the over 50 million Americans who suffer from chronic pain—and even that insignificant amount may never be appropriated by Congress.

Legislation that attempts to assure adequate pain control and supportive care for patients who have severe pain and are terminally ill requires the assurance of quality pain care and support programs. ONS continues to have serious concerns regarding the final effect this legislation could have for our patients if passed into law.

PREPARED STATEMENT OF PAIN CARE COALITION

The Pain Care Coalition is pleased to present this statement in connection with the Committee’s consideration of H.R. 2260, The “Pain Relief Promotion Act of 199.” The Pain Care Coalition is a national coalition that advocates for responsible pain care policies at the federal level. The Coalition was formed in 1998 by concerned organizations representing the interest of pain care professionals and their patients. Constituent members of the Coalition represent a broad spectrum of physicians and other health care professionals involved in the diagnosis and treatment of patients suffering from acute and chronic pain. Members also include those professionals who conduct biomedical and related research into the causes of pain and the effectiveness of diagnostic and therapeutic approaches to freeing patients from pain or lessening the pain of those who must live with it.

The Coalition appreciates the Committee’s interest in the issue of pain care. Pain is a major public health problem in this country. It effects people of all ages and at every stage of life. It is generally recognized that throughout the nation, and regardless of age, setting, or health status, severe pain is often under-treated or mis-treated, if not overlooked entirely. Nine out of ten Americans experience some sort of pain on a regular basis—monthly or more often. Fifty million Americans are partially or totally disabled by pain, and 46 percent of all Americans seek care for persistent pain at some point in their lives. Pain imposes a tremendous burden on these individuals and their families.

Pain also imposes a tremendous burden on the economy, and upon the health care system. 27 percent of American workers have missed work in the past year due to pain. For example, migraine alone affects 24 million people, the majority of them women in their 30’s and 40’s. This one painful disease alone leads to 157 million lost workdays each year at a cost to economic productivity estimated at over \$17 billion. Costs attributable to low back pain are even higher, and the total cost of pain to the economy is now estimated at over \$100 billion.

Pain accompanies a wide range of other clinical conditions such as cancer, heart disease and arthritis, among many others. This form of pain, referred to as “secondary” pain, requires treatment, as does the condition from which it arises. This pain is called “secondary” pain, because it is a symptom of the other condition or disease. “Primary” pain is when the brain or spinal cord themselves generates the pain, and no other condition is responsible for it. Pain, whether primary or secondary, requires aggressive and state of the art treatment. However, evidence abounds that neither primary nor secondary pain is adequately treated in this country. Recent studies of end-of-life care in hospitals, of the elderly in nursing homes, and of the general public in Michigan all reach the same conclusion: many, many people endure unnecessary suffering due to inadequate pain care.

Several bills addressing pain care issues in some manner have been introduced in this Congress. The Pain Care Coalition welcomes these initiatives as an important reflection of the growing awareness of and concern for pain as a public health priority in this country, and among policy-makers at the federal level. One of those proposals, the Pain Relief Promotion act, has been particularly controversial since its original introduction in 1998. The Pain Care Coalition was among many groups to express reservations about the bill then, and more recently about the revised version of the legislation which passed the House last fall.

These reservations have focused on concerns that the bill might have a “chilling effect” on the willingness of physicians to prescribe controlled substances for legitimate pain control purposes, particularly to patients at or near the end of life. These concerns have been based in part on confusion over whether the bill actually grants new authority to the Drug Enforcement Administration to police physician prescribing practices, and in part on fears that enactment of the legislation might influence the DEA’s use of its existing authority under the Controlled Substances Act.

Given these reservations about the House-passed bill, the Coalition, working with other interested organizations, has advocated for certain modifications to the bill to ensure that appropriate—and indeed sometimes aggressive—pain care would not be compromised by the fear of overzealous DEA scrutiny.

The Coalition is pleased to advise the Committee that these concerns have been heard, and that the Chairman’s proposed substitute for the House-passed bill incorporates important changes that the Coalition strongly supports. On the basis of those changes, the Coalition urges all members of the Committee to support the Chairman’s substitute.

First, by raising the standard of proof in certain DEA administrative proceedings to that of “clear and convincing” evidence, the substitute would ensure that whatever new law is made by this bill, if any, could be used against physicians only in the most clear cut cases, and not simply because “20/20 hindsight” raises suspicion about a physician’s intentions in prescribing controlled substances to terminally ill patients.

Second, and of equal or greater importance in the long run, are beneficial changes in the bill’s new initiatives to further education and training in appropriate pain care, including the legitimate use of controlled substances. By broadening these new authorities to include pain care generally, and not just palliative care at the end of life, the substitute ensures that the use of controlled substances will be viewed in context with the other diagnostic and therapeutic options available in this rapidly maturing field of medicine. To equate pain care only with the needs of the dying, or to promote the use of controlled substances while ignoring other more appropriate modalities would have been a disservice to millions of Americans who suffer daily from pain that is not related to terminal illness, and for which controlled substances are neither the most appropriate nor the most effective treatment.

Finally, the Coalition applauds that provision of the Chairman’s substitute which declares the next ten years to be the “Decade of Pain Control and Research.” Despite its prevalence as a leading health problem, pain has often been a largely invisible condition. It lacks a significant constituency at the Federal level, and this has contributed to serious under-investment in research and treatment in the pain field. A congressionally declared “Decade” will bring a much needed focus on pain in both the public and private sectors. It can be an important first step in stimulating further progress in research, training, and clinical care.

For all of these reasons, the Coalition is pleased to endorse the Chairman’s substitute to H.R. 2260. While some well-intentioned critics may still fear the “chilling effect” of *any* legislation to be implemented, even in part, by the Drug Enforcement Association, the Pain Care Coalition is persuaded that the substitute will not impede the legitimate use of controlled substances by the vast majority of pain care practitioners who will remain committed to providing appropriate pain and palliative care to terminal and other painful patients who, without such care, might be driven to consider the taking of their own lives.

The Pain Care Coalition applauds the Committee for its commitment to protecting patients in pain, and for focusing badly needed attention on issues affecting pain care policy at the Federal level. The Coalition welcomes the opportunity to work with interested members of Congress to advance legislative proposals that promote appropriate pain care—care that is increasingly available to reduce needless suffering throughout the population.

PREPARED STATEMENT OF PHYSICIANS FOR COMPASSIONATE CARE

SUMMARY STATEMENT

Physicians for Compassionate Care, an organization providing education about pain relief and palliative care, urges passage of the Pain Relief Promotion Act. This testimony to the U.S. House Judiciary Subcommittee on the Constitution, June 24, 1999. This new information falls into two categories. First, since hearings last June, the American Medical Association held intensive and comprehensive discussions before its entire House of Delegates, including representatives from the whole field of medicine. These meetings and subsequent negotiations thoroughly addressed all concerns raised by detractors of the Pain Relief Promotion Act. Second, new examples of the misuse of federally controlled substances for assisted suicide and euthanasia in Oregon have surfaced. These cases reveal failure to protect the mentally infirm and those under pressure from their families, involvement of health maintenance organizations in assisted suicide, failed assisted suicide attempts, and involuntary euthanasia in the hospice setting. These abuses make it increasingly clear that allowing the use of federally controlled substances for assisted suicides constitutes a public danger.

ANY LEGITIMATE MEDICAL CONCERNS ABOUT THE PAIN RELIEF PROMOTION ACT HAVE BEEN ADDRESSED

Widespread agreement exists, even among those not initially favoring the Pain Relief Promotion Act (PRPA), that funding for improved education and research about pain treatment and palliative care is much needed. Yet, while admitting that assisted suicide is not a medical procedure, that it constitutes a public danger, and that it should not be allowed, some detractors of the Pain Relief Promotion Act still claimed last fall that this bill might create new authority for the Drug Enforcement Agency (DEA) and might create new penalties for physicians, thereby having hypothetical "chilling effect" on the provision of pain treatment and palliative care. A second concern raised by some critics of the PRPA was that it might somehow alter the balance of federal and state authorities in the regulation of controlled substances and the practice of medicine. Aggressive promotion of such fears by those favoring assisted suicide led to further consideration by the American Medical Association (AMA) of its position supporting the PRPA. This time, the discussion took place in a full debate of the entire House of Delegates—the highest decision making body of the organization—resulting in clear reaffirmation of support for the Pain Relief Promotion Act. Physicians for Compassionate Care played a prominent role in these discussions. Reaffirmed support was followed by the negotiation of and agreement upon proposed new wording to reassure those few remaining critics that the Pain Relief Promotion Act creates no new authority of the DEA and does nothing to alter the role of the federal and state governments in the regulation of controlled substances.

The House of Delegates of the AMA, in that it has representatives from virtually all specialty societies and numerous other medical groups, both large and small, as well as from the state medical societies, represents 95% of practicing physicians in America. Even physicians who are not delegates to the AMA can have their voices heard at this meeting. Among all those who testified, there were no concerns about the Pain Relief Promotion Act raised other than these two—fear of a theoretical "chilling effect" and speculation about role of federal and state government in the regulation of the practice of medicine.

Data presented at those meetings and among physicians across the country made it abundantly clear that those few states that have enacted laws similar to the Pain Relief Promotion Act showed no "chilling effect." On the contrary, per capita use of morphine, increased. In Rhode Island, for instance, the per capita morphine use more than doubled after a similar law was passed. While per capita morphine use figures do not accurately reflect the adequacy of pain treatment, they do reflect levels of physician comfort in prescribing controlled substances. Close examination of the PRPA also showed that fears of new penalties were entirely unfounded, because the Pain Relief Act creates no new penalties. In fact, it provides new protection for physicians against existing penalties by making it perfectly clear, for the first time, what has always been true in medicine—that aggressive pain management can be appropriate medical care even if in rare instances it might inadvertently increase the risk of death. It was also pointed out that wording had already been read into the record of the United States Congress by the authors of the Act last fall, clarifying that the PRPA is not intended to create any new authority for the DEA. This careful examination of available data and of the Act itself showed that the fears of any possible "chilling effect" were entirely unfounded.

While it became very clear that the Pain Relief Promotion Act provided new protections for both physicians and patients, a few continued to harbor doubts concerning the roles of the federal and state governments. These concerns were addressed through lengthy discussions and the proposal of additional wording that clarifies that the Pain Relief Promotion act shall not be interpreted to alter the balance of the state and federal governments in the practice of medicine and the regulation of controlled substances. Now, the remaining few critics of the bill have been reduced to somewhat inconsistently arguing both that the Pain Relief Promotion Act may not give doctors enough protection and that it may give them too much protection. Careful consideration by the deliberative bodies of the field of medicine, however, have determined that a proper balance, which optimally protects both doctors and patients, has been achieved.

Virtually all the issues and fears raised now have been thoroughly studied and discussed and addressed with due deliberation to the satisfaction of the vast majority of physicians, even among those who initially may have harbored any concerns. The important details have been carefully addressed and settled. Yet, in the meantime, innocent patients in Oregon have continued to die untimely deaths through the administration of lethal doses of federally controlled substances using federal DEA licenses, instead of for appropriate pain treatment and palliative care. How many more American citizens will be given deadly doses of federally controlled substances using federal DEA licenses, before this enlightened piece of legislation is enacted, clarifying that federally controlled substances are to be used for pain treatment and palliative care, not for lethal overdoses?

NEW CASES CONFIRM THE PUBLIC DANGER OF ASSISTED SUICIDE

No Protection for the Mentally Infirm

Previous testimony (June 24, 1999) by Physicians for Compassionate Care demonstrated how allowing the use of controlled substances for assisted suicide led to the first publicly reported case of legalized assisted suicide in Oregon being given a lethal overdose instead of treatment for her depression, despite the well documented fact that she had been diagnosed as depressed. Since that time, another case, this time a woman with dementia under pressure from her family was given assisted suicide by her health maintenance organization (HMO) doctor using federally controlled substances.

Mrs. Kate Cheney was an elderly, Oregon woman with growing dementia and the diagnosis of a potentially terminal cancer (Barnett, 1999; Smith, 1999; Hamilton, 2000). When her daughter accompanied her to her doctor's appointment to formally request assisted suicide, the doctor did not agree with that course of action. It was the daughter (Barnett, 1999), not the patient, who then insisted the mother have a new doctor within her HMO, Kaiser Permanente. The doctor change for the mother was granted to the daughter.

This second doctor was willing to give Mrs. Cheney assisted suicide and arranged for psychiatric for evaluation, because it was standard at this HMO in its assisted suicide procedure. The psychiatrist, who released a written report to the newspaper, found that Mrs. Cheney had short-term memory deficits and dementia. The assisted suicide request appeared to be the daughter's "agenda" (Barnett, 1999). The daughter who also accompanied Mrs. Cheney to this appointment, "coached her" in her answers, even when the psychiatrist asked her not to do so. Concerning the patient, the psychiatrist observed, "she does not seem to be explicitly pushing for this" (Barnett, 1999). She was deemed lacking sufficient capacity to weigh options about assisted suicide; thus, she was not eligible for doctor-assisted suicide.

The patient accepted this assessment. Her daughter, however, "became angry" (Barnett, 1999). It was the daughter, not the patient, who then "decided on a second competency evaluation" (Barnett, 1999). Kaiser HMO apparently authorized this second off-panel mental health evaluation. This new psychologist admitted the patient could not even remember when she was diagnosed with terminal cancer, although it had only been within the last three months. She also wrote that the patient's "choices may be influenced by her family's wishes and her daughter, Erika, may be somewhat coercive" (Barnett, 1999). Nevertheless, she approved the assisted suicide.

With two conflicting mental health opinions, the final decision came down to yet another Kaiser HMO doctor-administrator, Robert Richardson, who approved giving a lethal overdose to this elderly woman under pressure from her family. Kaiser Permanente is a fully capitated HMO with a profit sharing plan for its doctors. Dr. Richardson may or may not have directly thought of the economic advantages to his organization and his own profit sharing plan in making his decision about Mrs. Cheney. Nevertheless, the existence of an economic incentive program put in place pur-

posefully to induce doctors to reduce medical costs, an incentive system that in this case favored doctor-assisted suicide over expensive medical care, did exist and should be noted.

The problems with this well documented case in Oregon (Barnett, 1999; Smith, 1999; Hamilton, 2000) were not reported in the Oregon Health Division (OHD) report (Sullivan et al., 2000). And psychiatric evaluation served no protective function for her, since an opinion protecting her against assisted suicide, merely prompted her daughter, not the patient, to search for another opinion.

Outside pressure or influence for assisted suicide is not at all uncommon, once assisted suicide becomes legalized. In fact, in the Netherlands, over half the doctors feel it is fine to actually suggest to a patient who has not requested it that assisted suicide may be appropriate for them (Hendin et al., 1997). Numerous cases of patients under family pressure to commit assisted suicide have been recorded in the Netherlands (Canady, 1996). As the Cheney case illustrates, these kinds of pressures are already in Oregon. For those and other reasons, use of federally controlled substances for assisted suicide presents a public danger.

Assisted Suicide Inevitably Expands to Include Involuntary Euthanasia

Five seriously ill patients in Sheridan, Oregon, hospice were given excessive doses of a federal controlled substance, morphine, by Michael J. Coons, between November 1977 and January 1998, just after the Oregon assisted suicide law was implemented, according to criminal investigators (Tims, 2000a). The overdoses resulted in the deaths of four of the five patients. Some patients were determined by investigators to have refused pain medication and were given it nonetheless. Another was given repeated narcotic doses when he was unconscious or unresponsive (Tsao, 2000). The one woman who survived had been placed on hospice, which meant that she had been determined to be "terminally ill" and to have less than six months to live, by the nurse who eventually gave her a life threatening overdose. She turns out not to have met criteria for "terminal illness" after all, because two years later, she is still alive. Her experience with the attempts to kill her with a lethal overdose of federally controlled substances, however, have undermined her trust in the medical care system and at night she now makes sure the door to her room is always locked (Tims, 2000b). The other four patients did not live to struggle with their fears.

In Oregon, where the lives of the seriously ill have been devalued by the acceptance of giving some patients deadly overdoses of federal controlled substances, there was an inordinate delay in the investigation of these cases. Complaints were dismissed by agency after agency, until the persistence of the daughter of one of the victims, finally succeeded, one-and-a-half years later, in demanding an inquiry (Tims, 2000b). The daughter of the single survivor said she did not know about the overdose of her mother until it was published in the newspaper, two years later. She was outraged (Tims, 2000a).

Erosion of the conditions of trust in the doctor-patient relationship has already begun in the state of Oregon, as has already happened in the Netherlands. While some supporters of legalized assisted suicide using federally controlled substances might wish to argue that the overdosing of these five hospice patients was an aberration resulting from a single deranged individual's action, there is considerable statistical evidence to the contrary. Once assisted suicide using controlled substances is allowed in some circumstances, individual medical personnel increasingly interpret that acceptance as approval of other kinds of killing in the medical setting.

In the Netherlands, where doctor-assisted suicide has been allowed longer than in Oregon, it has been clearly demonstrated that killing in the medical setting moves from doctor-assisted suicide to active euthanasia, from the terminally ill to the chronically-ill, from voluntary to non-voluntary (Canady, 1996). For each voluntary assisted suicide in the Netherlands, there are more than twice as many cases of involuntary euthanasia. As the U.S. Supreme Court observed, "The Dutch government's own study revealed that in 1990, there were 2,300 cases of voluntary euthanasia (defined as 'the deliberate termination of another's life at his request'), 400 cases of assisted suicide, and more than 1,000 cases of euthanasia without an explicit request. In addition to these latter 1,000 cases, the study found an additional 4,941 cases where physicians administered lethal morphine overdoses without the patient's explicit consent" (U.S. Supreme Court, 1997). It is not surprising, then, that such expansion of assisted suicide using federally controlled substances to the area of involuntary euthanasia is already becoming apparent in Oregon.

State Monitoring is Ineffective

The Oregon Health Division (OHD) review of 1998 reported cases of assisted suicide, all of whom received lethal overdoses of federally controlled substances, was

particularly criticized because of “its failure to address the limits of the information it has available, overreaching its data to draw unwarranted conclusions” (Foley and Hendin, 1999). The report’s declaration of a lack of problems was clearly unwarranted. The first publicly reported case of assisted suicide was noted to have been diagnosed with depression, yet the report failed to reveal this fact. Neither did the report mention that same woman mentioned that concerns about finances were one motivating factor in her decision for assisted suicide. The OHD apparently overlooked those problems and other problems, because it only interviewed the doctors who prescribed the lethal drugs and who therefore had a vested interest in justifying their recent behavior.

Since that time, OHD has issued a second report (Sullivan et al., 2000) with similar unwarranted reassurances based upon similar methodological shortcomings (Hamilton, 2000). This year, the OHD also interviewed some family members, but those family members were chosen by the assisted suicide doctors themselves and were also motivated to justify their recent behavior. The patients themselves were never interviewed by OHD prior to their being given overdoses of controlled substances; neither were the medical records systematically examined, with due consideration for patient confidentiality, by outside researchers.

There is solid evidence that not all the cases were reported. At least one assisted suicide attempt resulted in such disturbing symptoms that the family called 911 (Hamilton, 2000). The patient was taken to the hospital and resuscitated. This case apparently was never reported. This instance when a known failed assisted suicide case was not reported suggests that there is skewed reporting with complications being hidden. Assisted suicide and euthanasia advocate, Dr. Sherwin Nuland (2000) cast doubt on the credibility of the Oregon report when he observed that a Dutch report in the *New England Journal of Medicine* indicated 18% of assisted suicide attempts needed to be ended with lethal injection, usually due to complications (Groenewoud et al., 2000), yet the OHD insisted it has yet to find a complication.

The OHD also failed to mention documented dementia in the Kate Cheney case, similar to its failure to mention the diagnosis of depression in the first publicly reported case that should have been discussed in the first report. It did not mention known multiple or conflicting mental health opinions. It only mentioned that 10 of 27 cases were referred for such evaluations, but said nothing about the results.

Neither did the OHD report that there were any instances of family pressure or coercion, despite the fact that two mental health professions were known to have found such factors present in the Kate Cheney case. It is not known in how many other cases such pressures may have played a part.

Concerning the issue of economic pressures, OHD only asserted that all the assisted suicide cases were insured. It provided no information about what the financial arrangements of the insurance companies might be. It did not mention the capitated and profit sharing plan of Kaiser HMO where Mrs. Cheney died. It did not mention the rationing of health care and the barriers to mental health care in the Oregon Health Plan (described in previous testimony, June 24, 1999) and upon which four cases had to rely. And, it said nothing about how many patients belonged to HMOs which put limits on payments for in-home palliative care at very low amounts, yet fully fund assisted suicide, as Qual Med HMO is reported to do. Instead of gathering useful information, the OHD once again overreached its data and provided unsubstantiated reassurances.

The inability to monitor and control assisted suicide using federally controlled substances with federal DEA registrations, once it is legalized, further demonstrates the public danger of allowing use of federally controlled substances for giving lethal overdoses to American citizens

Assisted Suicide Expands to Include Legalized Lethal Injection

In previous testimony, the case of Patrick Matheny’s failed assisted suicide attempt was described. Mr. Matheny was a man with amyotrophic lateral sclerosis (ALS), who received through the mail a huge quantity of barbiturates prescribed by an assisted-suicide doctor (Barnett 1999). After two attempts at swallowing the contents of the large number of capsules failed, because of his medical condition, his brother-in-law said he “helped” him die and complained that Oregon’s suicide law discriminates against those who cannot swallow. The body was cremated within a day; consequently, no autopsy could ascertain the cause of death. Doctors and other citizens demanded that the prosecutor investigate the death, because illegal suffocation of the patient has been the most frequent method of “helping” patients die when assisted suicide attempts fail.

In response to inquiry, Oregon’s Deputy Attorney general issued an opinion indicating that lethal injection may need to be accepted once assisted suicide is accepted, because Oregon’s assisted suicide law does not provide “equal access” to its pro-

visions by disabled people who cannot swallow and may violate the Americans with Disabilities Act. The important legal implication of such failed assisted suicide cases is that they are bound to bring in lethal injection. That is what has happened in the Netherlands (Canady, 1996; Hendin et al., 1997). That is the dilemma prominent euthanasia proponent, Dr. Sherwin Nuland (2000), raised in the *New England Journal of Medicine*—if doctors are going to start carrying out assisted suicides, they will need lethal injection to finish the job—and lethal injection clearly gives power and control to doctors, nurses, and health care systems, not to the patient. And that is what is being brought up already by Deputy Attorney General David Schuman in Oregon.

The United States Supreme Court, as discussed in its 1997 decision, *Washington et al. v. Glucksberg*, stated “. . . it turns out that what is couched as a limited right to ‘physician assisted suicide’ is likely, in effect, a much broader license, which could prove extremely difficult to police and contain.” The inevitable progression to lethal injection, which occurred in the Netherlands, is already occurring in Oregon.

CONCLUSION

The need for improved education and research to promote pain and palliative care is overwhelming. The Pain Relief Promotion Act makes provision for improving such education and research about pain treatment and palliative care. It clarifies to physicians, nurses, and state medical boards, as well as to law enforcement personnel, that provision of pain medicine is a legitimate medical practice, even if in rare instances there may be an added risk to a patient’s life. Since previous testimony presented by Physicians for Compassionate Care, June 24, 1999, any legitimate concerns about a hypothetical “chilling effect” or change in the balance of federal and state jurisdictions in dealing with controlled substances have been alleviated.

During the same time interval, patients in Oregon have continued to die untimely deaths, being given lethal overdoses of federally controlled substances instead of pain treatment and palliative care they deserve. There has been the revelation of yet another case of a mentally infirm woman not being protected against assisted suicide in an HMO and under pressure from her family. There have been reports of assisted suicide expanding to the practice of involuntary euthanasia in the case of hospice patients. And there have been failed assisted suicide attempts, resulting in a call for introduction of more sure methods of ending the lives of vulnerable patients, that is, lethal injection. These cases and the failure to report any of these documented tragic cases in official reports make it clear that allowing the use of controlled substances for assisted suicide creates a public danger.

There already have been too many deaths of American citizens caused by overdosing vulnerable patients with dangerous federally controlled substances. It is time to stop the killing of American citizens using federal DEA registrations to prescribe federally controlled substances for lethal overdoses instead of for needed pain treatment and palliative care. Physicians for Compassionate Care urges you immediately to pass the Pain Relief Promotion Act.

—Respectfully submitted, N. Gregory Hamilton, M.D.

REFERENCES

- Barnett, E.H. (1999a). “Is Mom Capable of Choosing to Die?” *Oregonian*, October 17, 1999, G1&2.
- Barnett, E.H. (1999b). “Man with ALS Makes up his Mind to Die.” *Oregonian*, March 11, 1999, D1.
- Canady, C.T. *Physician Assisted Suicide and Euthanasia in the Netherlands: A Report of Chairman Charles T. Canady to the Subcommittee on the Constitution of the House Committee on the Judiciary*, 104th Cong., 2d, 10–11 (Comm. Print 1996).
- Foley, K. and Hendin, H. (1999). “The Oregon Report: Don’t Ask, Don’t Tell.” *Hastings Center Report* 29:37–42.
- Groenewoud, J.H. et al. (2000). “Clinical Problems with the Performance of Euthanasia and Physician-Assisted Suicide in the Netherlands.” *New England Journal of Medicine* 342:551–556.
- Hamilton, C. (2000). “The Oregon Report: What’s Hiding Behind the Numbers.” *Brainstorm*, March, 2000, pp. 36–38.
- Hendin, H. et al. (1997). “Physician-Assisted Suicide and Euthanasia in the Netherlands: Lessons from the Dutch.” *Journal of the American Medical Association* 277:1720–1722.
- Nuland, S.B. (2000). “Physical-Assisted Suicide and Euthanasia in Practice, *New England Journal of Medicine* 342:583.
- Sullivan, A.D. et al. (2000). “Legalized Physician-Assisted Suicide in Oregon—The Second Year,” *New England Journal of Medicine* 342:598–604.

- Smith, W.J. (1999). "Suicide Unlimited in Oregon." *Weekly Standard*, November 8, 1999, pp. 11-14.
- Tims, D. (2000). "Sheridan patient Recalls Ordeal," *Oregonian*, March 26, 2000, A1.
- Tims, D. et al. (2000). "Hospice Faces Inquiry after Four Deaths" *Oregonian*, March 16, 2000, A1.
- Tsao, E. (2000). "Some Patients Who Died Refused Morphine, Records Show." *Oregonian*, March 26, 2000, A10.
- United States Supreme Court, *Washington v. Glucksberg*, 1997.

PREPARED STATEMENT OF HARVEY L. ROSE, M.D.

My name is Dr. Harvey L. Rose. I have been a board certified family practitioner in the Sacramento area for the past 38 years. As a physician on the "front lines" of delivering medical care, I have both witnessed and experienced with my own patients the detrimental impact of governmental regulatory controls on the decisions of medical practitioners in treating their patients with acute and chronic pain. I have devoted the past twenty years of my practice to protecting the rights of patients who suffer from debilitating chronic pain in their efforts to obtain adequate pain relief, educating physicians about treating chronic pain and protecting their rights to adequately and effectively do so; developing policy and legislation concerning the treatment of chronic pain; and, finally, educating and reforming the regulatory agencies themselves with regards to the use of opioid analgesics for the treatment of chronic pain.

When other reasonable and affordable methods have failed to control patients' chronic pain, the use of opioids has proven to be an effective treatment, with little to no risk of addiction when used for legitimate pain. These medications provide comfort, improved function, and improved quality of life, with essentially no detrimental effects except, perhaps, for constipation. Despite the safety of these medications, for years, they have been underutilized because the physicians' fears of getting into trouble with various regulatory agencies, particularly narcotic enforcement at the state level and the DEA at the federal level. The misguided efforts of these agencies often focused on the *quantity* of medication being prescribed, rather than the individual medical requirements of each patient's condition and the improved quality of life achieved by taking these medications. During the dark days of the 80s and into the early 90s, frequent news reports featured doctors being arrested, handcuffed, and charged with treating so-called drug addicts. In reality, these were chronic pain patients, both cancerous and non-cancerous, who had been through the medical mill; nothing else adequately relieved their pain except for controlled substances, particularly the opioid narcotic analgesics. Even cancer specialists were not immune to regulatory interference: Dr. Ron Blum, oncologist at New York University, was arrested in his office for prescribing more narcotics than his colleagues—no small surprise, as he was NYU's chief of oncology! And Dr. Roman DeSanctis, Dr. Henry Kissinger's personal cardiologist, was charged by the medical board of Massachusetts for improper use of narcotic medications for pain management—a charge that was later overturned. With high profile physicians like these being arrested and charged with overprescribing narcotics, regulatory agencies created a climate of fear and intimidation among all physicians, resulting in a widespread reluctance to prescribe controlled substances for pain relief for the needless suffering of thousands with pain.

In order to restrain these regulatory agencies, physicians and patients lobbied their state legislatures. Their efforts resulted in two Intractable Pain Treatment Acts, first in Texas in 1989, then in California in 1990. Other states followed suit with similar intractable pain treatment acts and pain patients' bill of rights. The state of California has since lead the way in such efforts, with guidelines in the use of controlled substances in the treatment of pain issued by the state medical board and educational programs by the California Medical Association instructing doctors on the appropriate use opioid analgesics. I have personally been involved in the California initiatives along with my state senator Leroy Greene in getting organized medicine, the legislature and state enforcement agencies to change archaic attitudes in the use of these substances to relieve pain and suffering. I was also involved in supporting the passing of Oregon's Intractable Pain Treatment Act, sponsored by State Senator Kennemer. Personal experience with this issue made the senator aware of the need of this legislation. A few years prior, Senator Kennemer's wife was terminally ill with cancer when she was refused more pain medicine on the erroneous basis of its being addictive. (In my opinion, it was the scarlet letter "Arrest" rather than "Addiction" that kept her doctors from adequately treating her pain, in spite

of the fact that she was terminal.) My own wife of 35 years had terminal metastatic breast cancer. After surgery for major pathological fractures, she was given by the hospital physician only 1 to 2 narcotic pain medicines every four hours prn—meaning she had to ask for it. Prior to surgery, she was taking the equivalent of 8 every three hours to control her pain. When she requested more pain medicine from the nurses, she was told “it wasn’t time yet”. My wife died three months later.

Nonetheless, we have continued to see gradual progress in this area. In recent years, the Joint Commission on Hospital Accreditation issued guidelines notifying hospitals and other outpatient facilities that they would be monitoring them to insure that pain is adequately treated, assessed, and managed.

* * * * *

We hope we have reached a point when this will no longer happen. Yet, I feel that the provisions in the Pain Relief Protection Act, even though they purport to give doctors more freedom in relieving pain and suffering, will halt our hard-won progress. The fear of the DEA becoming involved in doctors’ decisions in pain management, where intent will be questioned, is of particular concern. When doctors fear they are going to be second-guessed by some regulatory agency and will have to defend their decisions when it comes to treating pain and suffering, they are going to prescribe less medicine and thereby create more pain and suffering, which will potentially result in patients turning to other avenues of pain relief—be they street drugs, alcohol, or even suicide. I have the preliminary draft of a book called *Painful Exits* which chronicles the terrible decisions people have had to make for themselves and family members when severe pain goes inadequately treated. People have committed suicide and double suicides; doctors have been killed by patients because of inadequate pain treatment. Physicians have also killed family members because of their receiving inadequate relief from their pain. I have chronicled such events, but thankfully have found fewer of them occurring in the last few years due to a better climate of pain control and pain management in this country.

This bill, however, will crate a tremendous chilling effect for all physicians dealing with pain, both malignant, and non-malignant. Physicians will tend to undertreat and underutilize these very valuable pain relieving medications and return us to the dark ages of past decades where people suffered needlessly because doctors were afraid to do what they were trained to do. This bill is not necessary. At the state level across the country, there are laws and guidelines for physicians and the regulatory community to follow. We have the Federation of State Medical Board Guidelines. We have the Joint Commission on Hospital Accreditation. This bill is not needed, not only because we have all these other avenues now, but it will negate our progress and create a negative climate where people will again be told that they will “just have to learn to live with” their pain. The doctor’s discomfort level in treating their patients’ pain with these scrutinized medications will then be far greater than their patient’s own discomfort level and pain—and we know whose discomfort level will ultimately take precedence. I urge you to reject this bill. Let the states and the medical community continue to do what they have begun, maintain it, improve upon it, and keep the federal government out of it. Thank you.

